

THE
GENERAL RADIO

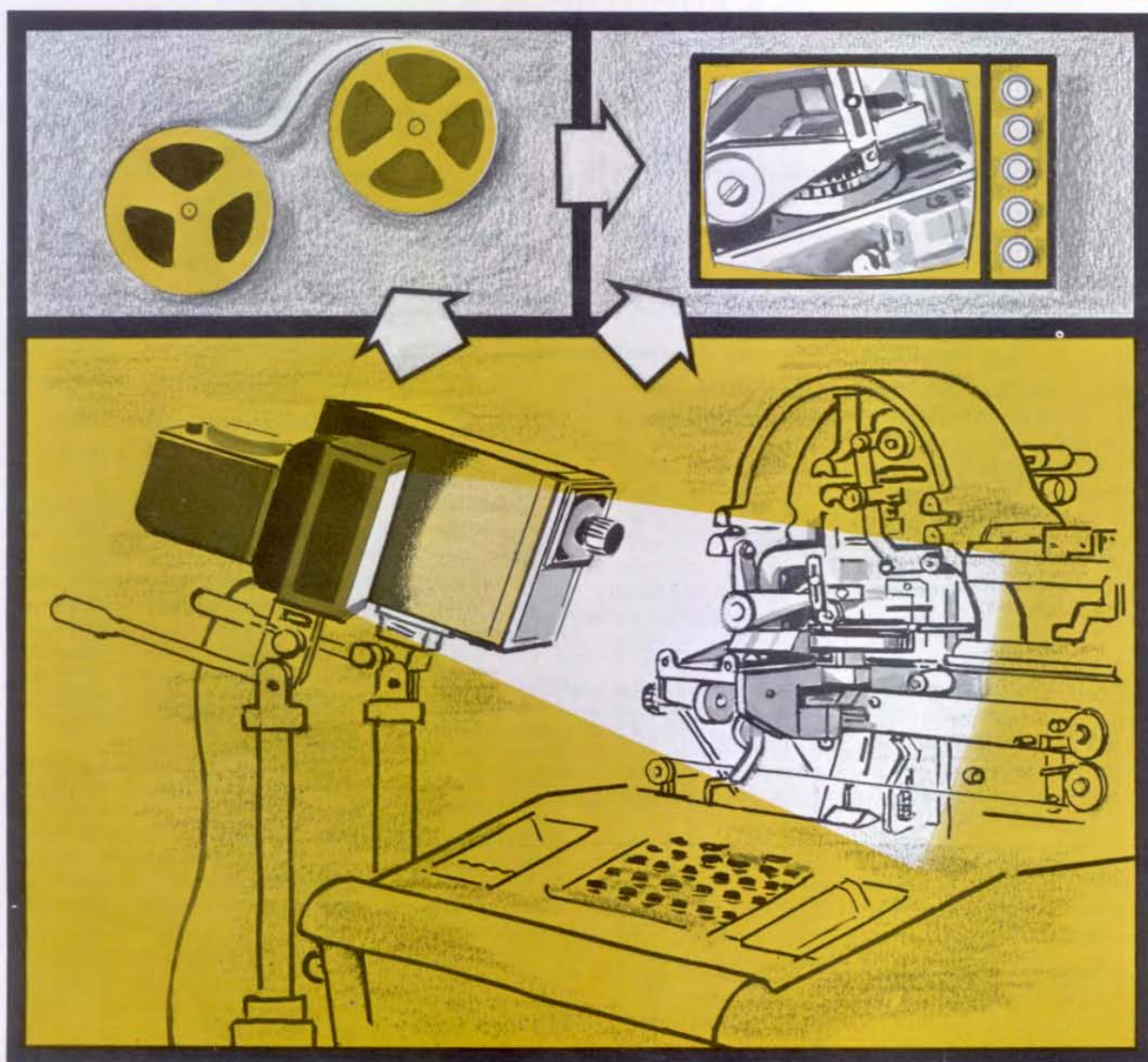

Experimenter

VOLUME 43
NUMBERS 9, 10
SEPTEMBER/OCTOBER 1969



IET LABS, INC in the GenRad tradition
534 Main Street, Westbury, NY 11590

www.ietlabs.com
TEL: (516) 334-5959 • (800) 899-8438 • FAX: (516) 334-5988

THE
GENERAL RADIO
Experimenter



VOLUME 43 NUMBERS 9, 10 SEPTEMBER/OCTOBER 1969

Detailed Viewing in Ambient Brightness	3
A Standard-Signal Generator Improves Its Versatility	7
The Honorable Society	8
Notes on FM Distortion in Varactor-Modulated Oscillators	9
Signal-Generator Output Calibration	12
Recent Technical Articles by GR Personnel	14
Damping Measurements of Resonance Bars	15
Reports from the Field	17

The *General Radio Experimenter* is mailed without charge to engineers, scientists, technicians, educators, and others interested in the instruments and techniques of electrical and electronics measurements. Address all correspondence to Editor, *General Radio Experimenter*, General Radio Co., West Concord, Mass. 01781.

© 1969 — General Radio Company, West Concord, Mass., USA

The Cover — Stroboscopic lighting and photography are wonderfully effective tools in the field of mechanical motion analysis. Too often, however, this application is obscured by illustrations of the use of strobe techniques in studies of the human figure in motion. The article in this issue, describing the new GR Strobolume, should convince our readers that this simple but efficacious tool is equally suited to studies of *mechanical* and *human* motion.

It was my pleasure to spend the last two weeks of August in Ottawa as Scientific Editor for Commission I, International Scientific Radio Union (URSI), during the XVIth General Assembly of URSI. The assembly meets to review the developments that have taken place internationally during the past three years in the many fields of radio science and to explore the areas of research and development urgently required during the ensuing three-year period.

There is, however, a more fundamental purpose behind the meetings. The assembly presents an opportunity for representatives of the national academies and scientific bodies not only to exchange ideas in the technical fields and to provide for arrangements to coordinate experiments but also to meet as persons. The latter perhaps is the one most important factor in the success of these meetings for it removes, for a short time at least, the political and geographical boundaries that separate nations.

From the international pool of technical information that flowed from the numerous technical reporters, the rising influence of the computer as a vital part of the measurement system was quite apparent. This influence became even more apparent during sessions that involved other commissions, who look to Commission I for help in linking instruments, people, and computers into a coordinated measurement unit.

Unquestionably, the complexity of our ever-expanding technology requires a more rapid adaptation to change. Therefore the interests and concern of Commission I, and of all other activities concerned with measurements and standards, must turn inevitably to technological innovation — to the coupling of man, instrument, and the computer to reach the goal of purposeful measurement research, from which come new and improved products and services.

The three-year period to the next General Assembly of URSI in 1972 will be an exciting time during which the data monster — the computer — will be tamed and managed to perform more meaningful and accurate measurements rather than to deluge man with reams of measurement data of questionable value.

C. E. White

C. E. White
Editor



IET LABS, INC in the GenRad tradition

534 Main Street, Westbury, NY 11590

TEL: (516) 334-5959 • (800) 899-8438 • FAX: (516) 334-5988

www.ietlabs.com



GR 1540 Strobolume with lamp head and three available control units.

Detailed Viewing in Ambient Brightness

The number of applications for the stroboscope has increased dramatically in the last few years, severely taxing the performance and features of existing equipment. One of the most important needs has been greater light availability from smaller packages, for operator convenience. The GR 1540 Strobolume electronic stroboscope was developed to meet this need. The GR 1540, now the brightest commercially available, general-purpose stroboscope, combines the features of modular construction with approximately 20 times the light output per flash when compared with previous stroboscopes such as the GR 1531 Strobotac® electronic stroboscope.

A NEW MOTION ANALYSIS TECHNIQUE

The combination of a stroboscopic light and relatively inexpensive closed circuit television equipment is an exciting and powerful new analysis tool that combines aspects of both visual and photographic viewing. With currently available tv equipment, there are no strobe interconnection or synchronization problems. These tv systems employ vidicon camera tubes. The vidicon "sees" and stores the pulsed image in a manner analogous to the human eye. The image is converted to a video signal (electronic) by a scanning beam that can be either played back immediately on a monitor or stored on magnetic tape by a video tape recorder. Suitable video systems (camera, VTR, monitor) today are available for as little as \$1,500. The vidicon is quite sensitive and performs well under varied light conditions.

With tv the operator can be at a location remote from the subject, camera, and strobe, which is of value in hazardous experiments such as observing rain erosion on the leading edges of rapidly rotating helicopter blades. The low cost of video tape and its long playing time, typically 30 to 60 minutes, make it practical to record entire tests such as monitoring development progress in a vibration-reduction program. These recordings may be rerun and reexamined as often as desired long after the test equipment has been torn down or the tested device has been modified. Quite obviously, such records may contain much more useful information than written notes. An additional feature of video taping is the availability of one or two audio channels for data logging.

Because the vidicon can store the pulsed images between flashes, this system makes it practical to extend stroboscopic visual analysis to machines moving so slowly that the eye would otherwise be subject to severe "flicker effect."

Perhaps the most exciting aspect of video storage is the "instant" and "single frame-by-frame" playback capability of the video tape that, unlike movie film, does not have to be sent out to be processed. This gives the operator such flexibility that the system can be used for troubleshooting machine malfunctions in real time or reducing the setup time of complicated machines.

With a slightly more sophisticated system, such as two cameras and two strobe lights, a split-screen technique can be used to view widely separated machine functions or operations with respect to each other, in exact time synchronism! Film becomes useless when the records have no further historical value; the tape may be erased and re-used.

VISUAL MOTION ANALYSIS

The new GR 1540 Strobolume electronic stroboscope is ideally suited as a supplement to visual analysis of almost any form of motion, repetitive or non-repetitive. It can be used as a continuously adjustable flashing source over a range from 30 to 25,000 flashes per minute or for no-contact speed measurements to 250,000 rpm. With a manual oscillator adjustment, the flashing range can be set to be at or near synchronism with a cyclically moving object, to give a visual image of stopped or slow motion.

Figure 1. Motion analysis with a still camera. Picture sequence is a permanent record of visual observations made to detect misbehavior of follower in contact with cam rotating at 3000 rpm. The technique combines synchronized flash plus continuous advancement of the time-delay control, to produce a high speed "still movie."

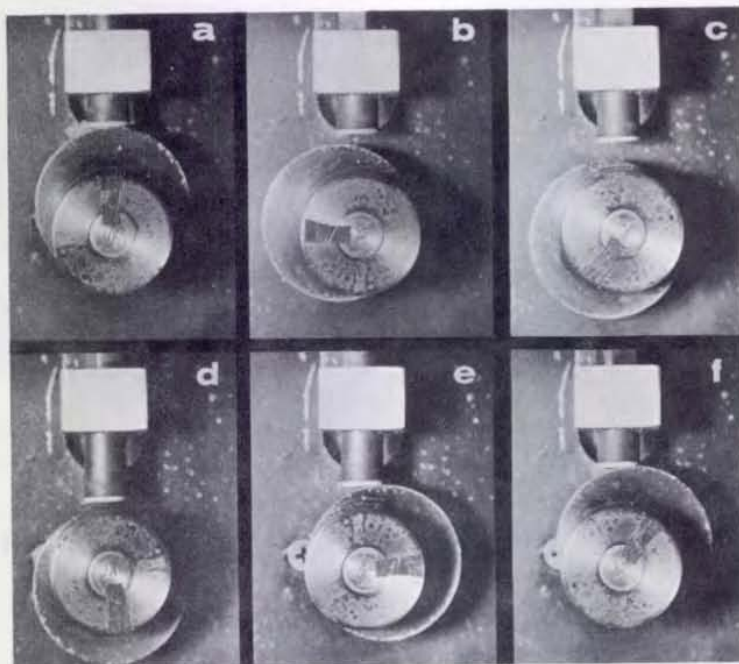

A second method of motion analysis employs a transducer, such as a photoelectric pickoff or a switch contacting mechanism, to sense the position of the object and to "trip" the Strobolume flash. A particularly useful feature is that, by the flip of a switch, the photocell can be made to respond to either light marks on a dark background or dark marks on a light background, or to contact opening or closure. The strobe flash rate follows any deviations in the speed of the moving object to produce a stationary visual image, thus eliminating the need for manual tracking of the oscillator dial. In addition, any point in the motion of the object can be examined if each flash occurs some time later than the corresponding synchronizing signal.

In the GR 1540, this time delay can be manually controlled by a continuously adjustable time-delay circuit. The same knob control used for varying the flashing rate also provides this adjustment over a range of from 100 microseconds to 1 second. The longer a flash is delayed, with respect to the synchronizer's signal, the farther along in its cycle the object will move before being illuminated. The visual image can thus be adjusted through the entire cycle of motion, if desired, and the operator is freed from manually tracking the oscillator to follow any speed variations.

A practical example (Figure 1) shows a cam and its misbehaving follower. Assume that the cam is rotating counter clockwise at 1800 rpm (30 rps or 0.033 second per revolution). With no time delay, the image will appear, as in Figure 1a, at the instant a photoelectric pickoff has sensed the light reflection from a piece of reflective tape mounted on the cam hub. Figure 1b shows what the stopped image would look like when 8.3 milliseconds (1/4 revolution) of time

delay have been introduced. As more and more time delay is added, Figures 1c through 1f, the cam can be seen in all phases of its motion. Thus, valuable phase information can be obtained about a moving object's behavior.

PHOTO-INSTRUMENTATION

In many studies, recording requirements can be met only using film as the storage or reference medium. The preceding technique can be used to take high-speed single-flash photographs with conventional cameras. With almost any conventional still camera connected to the X-sync-contact input on the Strobolume, plus the adjustable delay, photos can be taken of a moving subject at a specific point in its cycle. One can, in effect, create a high-speed "still movie" record of fast repetitive events, similar to that shown in Figure 1.

The GR 1540 also has a built-in provision for keying the oscillator manually or with camera contacts to take multi-flash or "flash-burst" photographs of relatively slow events.

Moving-film recording in high-speed photo-instrumentation has chiefly involved the use of high-speed movie cameras such as the Hycam*, with framing rates in the hundreds- or thousands-per-second range. Although the cameras are equipped with internal shutters to pulse the image to the film, a strobe light source such as the GR 1540 is often required to produce images of greater clarity and freedom from distortion. With strobe light as the high-speed shutter, the subject is viewed for microseconds per frame rather than milliseconds. Many high-speed cameras have the

*Red Lake Labs, Inc., Kifer Industrial Park, Santa Clara, California 95051.

much, and whether it is stretch or shrinkage, and can make any required paper-roll tensioning adjustments.

The high light-output levels from the GR 1540 not only make stroboscopic viewing practical under normal ambient light conditions but permit "see-through" inspection of many paper stocks when both sides are printed and front-to-back registration must be maintained.

There are many other troubles that are monitored stroboscopically in printing operations: color register, location and quality of perforations, punched and die-cut holes, quality of over-all printing. Too "mushy" an impression would indicate perhaps too light a pressure or possible trouble in the inking fountains. A blooming or compressing effect at the ends of printed lines would indicate paper misalignment. Hickies would indicate water spotting, and dot break up in half-tone areas would indicate printing cylinder wear. We are sure that the printer for the *Experimenter* is noting these points as the presses roll!

A FEW TECHNICAL DETAILS ABOUT THE GR 1540

The desire for illumination levels well above those of the GR 1531 Strobotac® electronic stroboscope has resulted in unique design solutions. A photographer generally requires the highest possible *light per flash*, which is proportional to the energy in Joules or watt-seconds discharged through the lamp. *Visual intensity*, on the other hand, is approximately equal to the lamp input energy per flash multiplied by the rate at which the lamp flashes.

To satisfy both applications requires a high order of heat dissipation from the strobe lamp. The Xenon-filled lamp supplied with the Strobolume is an efficient converter of electrical energy to light and is protected from overheating by an electronic governor that prevents driving the lamp at rates in excess of the maximum allowable for the corresponding intensity settings. In addition, the quartz envelope of the lamp is forced-air cooled to withstand safely the high locally developed temperatures, thus permitting continuous operation at any flash rate up to 25,000 per minute.

The spectral output of a quartz-envelope Xenon lamp extends from the near ultraviolet, through the visible, and into the near infrared light regions. The GR 1540 is thus an excellent source of pulsed ultraviolet and infrared light when these normally invisible wavelengths are required, such as for detecting fluorescent ink registration marks on printing presses. A plastic faceplate normally covers the reflector and absorbs the ultraviolet light, to prevent possible eye irritation from prolonged exposure.

OTHER FEATURES

There are several new features in the GR Strobolume to extend its flexibility to both experimenters and photographers.

- Mechanical adjustment of the lamp-reflector combination produces either a narrow or broad light beam for such diverse projects as viewing the wide web of an operating printing press by means of a narrow, horizontal beam or photographing a large moving subject by means of the normal rectangular beam pattern.



C. E. Miller was graduated from Yale University in 1960 with a B. Eng. degree and received his MS degree from Massachusetts Institute of Technology in 1966. He joined General Radio in 1960 and is an engineer in the Component and Network Testing Group. He is a member of IEEE, AOA, ATI, SPSE, and holds a patent for a constant offset frequency-generating device to produce slow-motion images.

- Light output is approximately *twenty times* greater than that of the familiar GR 1531 Strobotac under *continuous* operating conditions. It may be increased, at lower flash rates, by using a booster capacitor.
- Three control units presently are available to satisfy a wide variety of applications. Their modular construction permits operating flexibility and provides features required for a particular application at minimum cost; equally important, it permits future expansion as needs dictate.

FURTHER HELP TO EXPERIMENTERS

Most applications for strobe light fall, very broadly, into three categories: speed measurement, motion analysis, and photography. Only a few specific cases have been covered here, but a comprehensive coverage is contained in two GR publications:

Handbook of High-Speed Photography (\$1.00 U.S.)

Handbook of Stroboscopy (\$2.00 U.S.)

Readers will find both books to be of great value in their respective fields. In addition, a free subscription to a GR periodical, *Strobotactics*, is available upon request. This publication contains descriptions of new and interesting applications, as well as other information of interest to users of stroboscopic equipment.

—C. E. Miller

Complete specifications for the GR 1540 are available on the catalog page, included as a tear sheet inside the back cover of this issue, removable for insertion in GR Catalog T.

A STANDARD-SIGNAL GENERATOR IMPROVES ITS VERSATILITY

Most standard-signal generators do not provide adequate sweep capabilities. On the other hand, sweep-signal generators lack both short- and long-term stability in the cw mode and are therefore of little value in critical point-by-point tests. To meet the increasingly stringent requirements for both sweep and point-by-point testing of high-frequency networks up to 80 MHz, General Radio has made available several new models of the well-established GR 1003 Standard-Signal Generator.¹

Redesign of the auto-control model of the GR 1003 includes a permanent-magnet dc-motor drive with electronic speed control and a *second* horizontal-sweep output voltage at high level (1 V/1% Δf) to facilitate the display of narrow-band frequency sweeps. The original rf circuit design remains intact, with its high (1 ppm/10 min) carrier-frequency stability and with no need for a restabilization period following range changes.

The carrier-level-meter voltage scales are now calibrated in terms of voltage across a matched 50-ohm termination. This conforms to the current trend, described in this issue of the *Experimenter*, page 12; earlier models were calibrated in "volts behind" the 50-source resistance. If desired, "volts behind" can be obtained by multiplying the meter readings by 2.

The GR 1003 is an excellent instrument for measurement of very selective high-frequency networks by either sweep or point-by-point techniques. The slow-speed sweep, in conjunction with a storage oscilloscope display, is useful for measurement of pass-band characteristics. Two models include an internal crystal calibrator

that provides frequency markers at 1 MHz, 200 kHz, and 50 kHz for accurately defining specific points of a display. The high-output capability is free of spurious non-harmonic signals. A highly stable cw signal is available for frequency measurements, at specific values of attenuation, on steep slopes of response curves. Repeatability of the frequency-dial setting is assured by the typical low-frequency drift rate (1 ppm/10 min; residual fm < 3 Hz). An auxiliary rf output jack on the GR 1003 provides a convenient monitor point for a frequency counter, such as the GR 1191 or 1192.

Capabilities and features of the new auto-control model generator include:

- Operation between two front-panel-controlled limits, at continuously-adjustable rates, from $\Delta f/f$ ranges of 0.05%/s to 5%/s. Return sweep is fast and blanks out the rf output.
- Sweep widths with motor drive, varying from 0.2% to over a full octave, provide good transitions to the electronic sweep limits.
- Availability of large sweep voltages, even with narrow sweeps.
- Direct correlation between the sweep voltage and the frequency dial, which is calibrated to 0.25% limit of error, provides a logarithmic display with constant-percentage resolution for wide sweeps. Sweep end points can be determined directly from the corresponding main frequency-dial readings.
- Voltage versus frequency is essentially linear in narrow-band ($\leq 4\%$ sweep width) frequency applications, permitting linear interpolation between the established limits. (Display devices usually have horizontal-axis calibrations in volts per graticule division, thereby permitting direct conversion of the generator's 1V/1% Δf change into hertz.)
- Very narrow sweep widths can be accurately calibrated by use of two different settings of the calibrated $\Delta F/F$ control on successive sweeps (Figure 1). The pattern offset provides direct calibration of the horizontal sweep, measured in parts per million, by taking the difference of the two $\Delta F/F$ settings.
- Tuning by means of the coarse motor drive can be accomplished at any convenient speed.

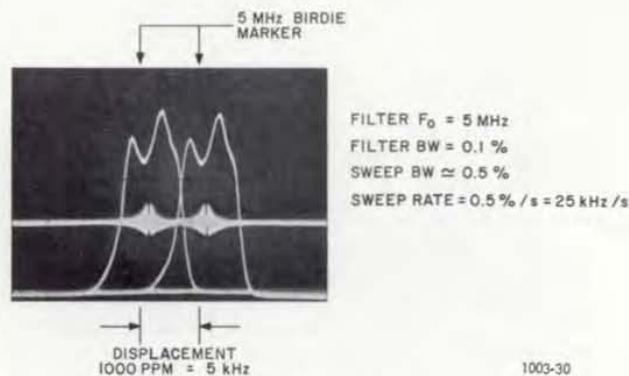

Figure 1. Successive-sweep technique as applied to calibration of very narrow sweep ranges.

¹Altenbach, R., "The 1003 Standard-Signal Generator," *GR Experimenter*, July-August 1967.

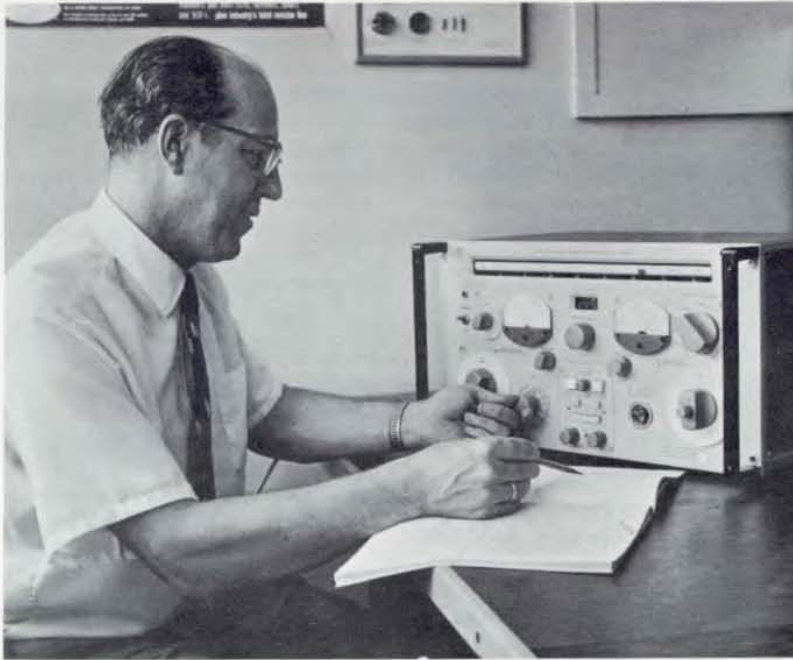

Figure 2. Engineer R. Altenbach adjusts auto-control model of GR 1003.

- Panel indicator lamps show the position of the sweep limit relative to the instantaneous tuning position, in the normal tuning mode. This directional feature greatly simplifies the initial set-up procedures.
- Programmable tuning with a positioning accuracy of 0.1% automatically seeks the programmed frequency at high speed.

- Operation on ac power from 50 to 400 Hz (50 to 60 Hz for basic model).
- Crystal-controlled markers (birdies), generated within two models of the instrument, can be displayed in either sweep mode. The markers can be switched to spacings as close as 50 kHz.

The basic sweep drive functions in a manner similar to that of the original design,¹ with some additions. The

NARROWBAND SWEEP VOLTAGE control mechanically engages a separate sweep potentiometer that provides better resolution and higher sweep voltage. In the WIDEBAND mode, the sweep voltage is derived from the analog output through an electrical centering circuit. This allows expansion of the horizontal sweep display for optimum resolution, without restriction of the expansion by the oscilloscope centering control.

A useful relationship between maximum permissible sweep rate (SR_{max}) and steepness of the selectivity characteristic to be measured is expressed:

$$SR_{max} \approx p (\Delta f_{6\text{ dB}})^2,$$

in which SR_{max} is expressed in Hz/s, $\Delta f_{6\text{ dB}}$ is the change in Hz for a 6-dB change in response at the steepest part of the response slope, and p is a constant whose value is of the order of unity.

As a practical example, consider a 9-MHz crystal filter with a 6-dB bandwidth of 2 kHz. This filter exhibits a maximum selectivity slope of approximately 100 Hz/6 dB. Maximum sweep rate is calculated to be 10 kHz/s or 0.1% at the 9-MHz center frequency.

Engineering development of this instrument was by R. K. Altenbach, Engineer, Signal Generator Group.

Performance changes for the new GR 1003 are noted on the tear sheet included with this issue.

¹Ibid.

The Honorable Society

A recent notice from the National Academy of Engineering announced the appointment of Dr. D. B. Sinclair as member of the Aeronautics and Space Engineering Board of the academy. Dr. Sinclair was elected to membership in the academy in 1965. Recognition for contributions made to the Institute of Electrical and Electronics Engineers as President also was accorded Dr. Sinclair in the form of a specially designed Past President's pin, awarded at the IEEE annual banquet in New York, March 25, 1969.



D. B. Sinclair

Notes on FM Distortion in Varactor-Modulated Oscillators

Consider the basic resonant circuit shown in Figure 1, with an inductance L , a fixed capacitance C_o , and a voltage-controlled capacitor C_v . The variable C_v is often made up of 2 varactors connected back to back to reduce rf distortion. However, this has no bearing on the modulation characteristic.

Because of the nonlinear varactor characteristic both modulation sensitivity and distortion terms are dependent on the operating bias V_o and on the ratio p of the fixed C_o to the variable C_v . An analysis of this situation was made to compute the distortion terms and to determine the most favorable operating conditions. The frequency-modulation characteristic is shown with exaggerated curvature in Figure 2. The results are presented here and also in a graph (Figure 3), showing only second-order effects, namely carrier-frequency shifts and second-harmonic distortion of the desired frequency deviation. Third-order effects are generally one or more orders of magnitude lower.

The varactor is characterized by the relationship

$$C_v = \frac{C_1}{V^n} = \frac{C_1}{(\phi + E)^n} \quad (1)$$

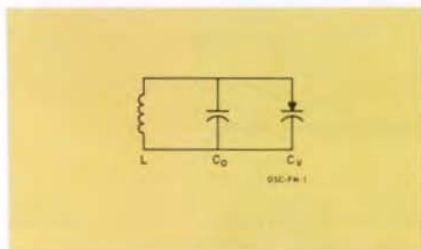

Figure 1. Schematic of basic resonant circuit.

where C_1 = capacitance at 1-V effective bias, i.e., 0.4 V applied bias in addition to the 0.6-V contact potential of a silicon device, and

- V = effective bias voltage = $\phi + E$
- ϕ = contact potential, typically 0.6 V for silicon
- E = applied bias voltage
- n = coefficient of varactor law.

Based on the resonant condition

$$\frac{1}{\omega^2} = L(C_o + C_v) \quad (2)$$

and the series expansion

$$\omega = \omega_o + \Delta\omega_m + \frac{\omega''}{2(\omega')^2} (\Delta\omega_m)^2 + \frac{\omega'''}{6(\omega')^3} (\Delta\omega_m)^3 + \dots, \quad (3)$$

the following terms were derived:

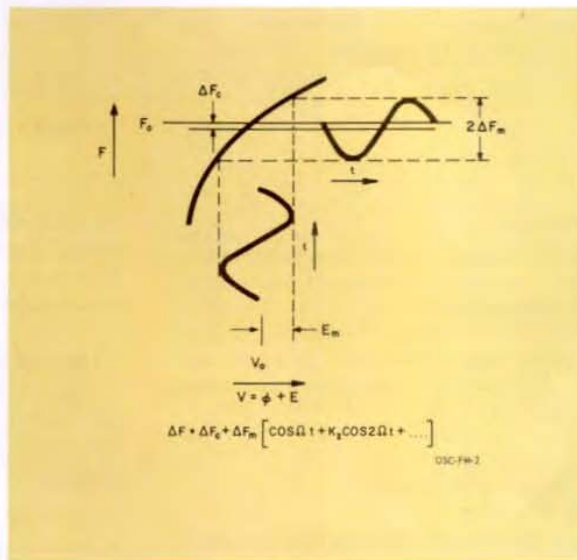
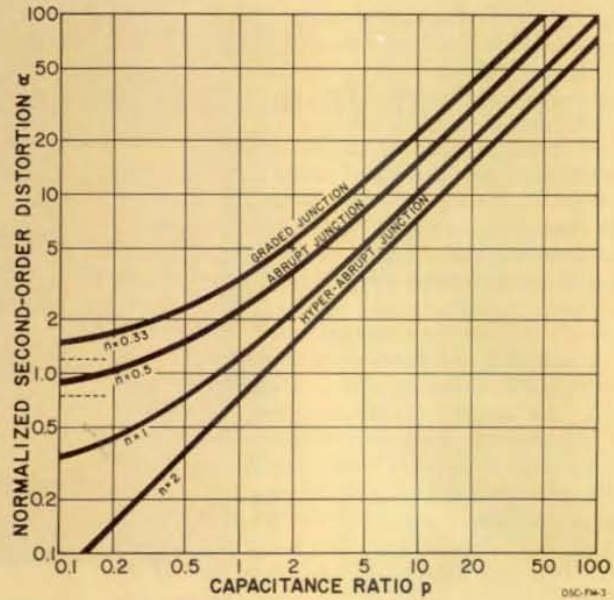

Figure 2. Frequency-modulation characteristic (exaggerated curvature).



$$\alpha = \frac{K_2}{\Delta F_m / F_o} = \frac{\Delta F_c / \Delta F_m}{\Delta F_m / F_o} \cdot \frac{3}{4} \left[\frac{2(n+1)(1+p)}{3n} - 1 \right]$$

$$p = \frac{C_o}{C_{V_o}}$$

n = COEFFICIENT OF VARACTOR LAW
 K_2 = 2nd HARMONIC DISTORTION
 ΔF_c = CARRIER SHIFT DUE TO MODULATION
 ΔF_m = PEAK-FREQUENCY DEVIATION
 F_o = CARRIER FREQUENCY BEFORE MODULATION

Figure 3. Second-order distortion effects.

(1) Modulation Sensitivity

When a modulating voltage E_m is applied superimposed on an effective dc bias V_o , the resulting frequency deviation can be expressed in a normalized form by

$$S_m = \frac{\Delta F_m / F_o}{E_m / V_o} = \frac{n}{2(1+p)} \tag{4}$$

where ΔF_m = peak frequency deviation
 F_o = carrier frequency
 p = the capacitance ratio at the operating point V_o ,

$$= \frac{C_o}{C_{V_o}} = \frac{C_o}{C_1} V_o^n$$

Obviously the largest modulation sensitivity occurs with the lowest bias and when the varactor represents the only capacitance in the circuit. Because of unavoidable stray capacitances, this condition can never be quite reached.

(2) Second-Harmonic Distortion

The coefficient K_2 is the ratio of the second harmonic to the fundamental of the frequency deviation. When K_2 is normalized to the fractional deviation $\Delta F_m / F_o$, we get the relation

$$K_2 = \alpha \frac{\Delta F_m}{F_o} \tag{5}$$

The function α is shown mathematically and in graphic form in Figure 2 for various values of n and p . Distortion decreases

with larger n and with lower fixed capacitance C_o . A hyper-abrupt junction-type varactor with $n = 2$ could make the distortion vanish in the absence of C_o .

With the more generally used varactors, for which $n < 2$, the inherent distortion cannot be reduced below a minimum value.

(3) Carrier Shift with Modulation

The same factor K_2 also describes the carrier shift ΔF_c in a normalized form

$$\frac{\Delta F_c}{\Delta F_m} = K_2 = \alpha \frac{\Delta F_m}{F_o} \quad (6)$$

The relative shift in terms of the peak deviation is the same as the second-harmonic distortion.

(4) Third-Harmonic Distortion

Generally third-order effects are one or two orders of magnitude lower than second-order terms. For reference the term for the third-harmonic distortion is included here:

$$K_3 = \beta \frac{\Delta F_m}{F_o}$$

$$\text{with } \beta = \frac{1}{6} \left\{ \frac{(n+1)(n+2)}{n^2} (1+p)^2 - 3 \left[\frac{n+1}{n} (1+p) - \frac{1}{2} \right] \right\}$$

Conclusions

If lowest distortion is a main criterion, three conditions should be met simultaneously

- use of high- n varactors
- operation at lowest possible bias
- maintenance of the fixed capacitance C_o at a minimum.

For 1% distortion, the percentage frequency deviation is limited to $(1/\alpha)\%$, which is typically 1% or less deviation.

The second condition also corresponds to operating with maximum modulation sensitivity.

Use of the Graph

Let us take an example to illustrate the use of the graph.

Assume an oscillator in the fm broadcast band 88 to 108 MHz. Suppose we want frequency modulation with 75-kHz peak deviation and 1% distortion or less. How much fixed capacitance can we tolerate?

The distortion is largest when the percentage deviation is largest, which occurs at the lowest carrier frequency (88 MHz). There, 1% distortion ($K_2 = 0.01$) makes $\alpha = 0.01 \times 88/0.075 = 11.7$. For this value of α we can read from the



R. K. Altenbach is a graduate of the Technical University of Karlsruhe (Dipl. Ingr., Electrical Engineering and Communications, 1948) who held technical positions with Siemens & Halske, Canadian Marconi, Hermes/Ittek, and Raytheon. He joined General Radio in 1963 and presently is an engineer in the Signal Generator Group. He is a member of IEEE and also served on EIA Committee TR14.

graph a value of $p = 7.3$ for an abrupt junction-type varactor, i.e., the fixed capacitance C_o should not exceed 7.3 times the varactor capacitance C_v .

f_c	ΔF	K_2	α	p	Capacitance		
					fixed	variable	total
88 MHz	75 kHz	0.01	11.7	7.3	C_o	$0.137C_o$	$1.137C_o$

If the same circuit were to be operated at the high end (108 MHz) of the band, we could reduce L to 2/3 of the value at 88 MHz and keep the same capacitances; p and α remain unchanged, and the distortion would be slightly reduced.

$$K_2 = \frac{\Delta F}{f_c} \alpha = \frac{0.075}{108} \times 11.7 = 0.00812 \text{ or } 0.81\%$$

The carrier shift with modulation would also be 1% or 0.81% of the frequency deviation, i.e., 0.75 kHz at the low end, 0.61 kHz at the high end.

-R. K. Altenbach

Signal-Generator Output Calibration

Considerable confusion has been engendered over the years by the existence of two competing methods of output voltage calibration for standard-signal generators, namely the emf or open-circuit or "volts behind" calibration and the matched output or "volts across" calibration.

Fundamental Relationships

Unfortunately no system of output calibration can absolve the engineer or technician of the need to understand his measurement technique and the equivalent circuits to which the metered voltages apply. In principle, it is unimportant which way the generators are calibrated so long as the method is clearly indicated on the panel of the instrument. The basic elements of the situation are shown in Figure 1.

The source voltage E_S is only available at the generator output terminals for a no-load or "open-circuit" condition. It can be shown that, for a *lossless* transmission line, the load voltage E_L is related to the source voltage E_S as follows:

$$E_L = E_S \frac{Z_L}{Z_S \left(\cos \beta \ell + j \frac{Z_L}{Z_o} \sin \beta \ell \right) + Z_L \left(\cos \beta \ell + j \frac{Z_o}{Z_L} \sin \beta \ell \right)} \quad (1)$$

where Z_S = source impedance
 Z_o = characteristic impedance of line
 Z_L = load impedance
 β = phase constant of line
 ℓ = length of line

In general, either Z_S , or Z_L , or both, may be frequency dependent complex quantities, so the calculation is not trivial. The situation is considerably simplified if the transmission line is omitted. Letting $\ell = 0$, Equation (1) reduces to:

$$E_L = E_S \frac{Z_L}{Z_S + Z_L} \quad (2)$$

In some ways more interesting is the observation that, when Z_S is chosen to be equal to Z_o , Equation (1) again reduces to

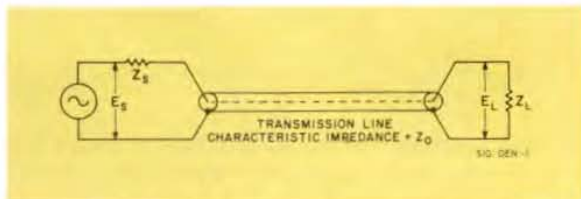

Figure 1. Basic calibration elements.

Equation (2) except for an additional phase shift between E_S and E_L due to the presence of the line. Thus, for $Z_S = Z_o$, the magnitude of the open-circuit voltage at the output end of the transmission line is the same $|E_S|$ that would exist in the absence of any transmission line and is of course *independent of line length*. The result is that the magnitude of E_L depends solely on Z_L and not on some special conspiracy which may or may not provide a conjugate match with a complex Z_S .

For the special case of a purely resistive source $Z_S = R_S$ and $Z_L = Z_o = R_S$ we have a completely matched system whose equivalent circuit is shown in Figure 2a. The generator now delivers to the load the maximum power of which it is capable; this is called the available power, P_{AV} . Defining E_{LM} to be the load voltage under this matched condition, we have:

$$E_{LM} = \frac{E_S}{2} \quad (3)$$

$$P_{AV} = \frac{E_{LM}^2}{R_S} = \frac{E_S^2}{4R_S} \quad (4)$$

P_{AV} is usually measured in milliwatts, and generally calibrated in decibels relative to a one-milliwatt reference (dBm). E_{LM} is the value which is calibrated in the "volts across" system, whereas E_S is the value calibrated in the emf or "volts behind" system.

Historic Background

The rivalry between calibration systems has historic roots in the meeting, in the vhf region, of an upward-bound low-frequency technology, which was for many years open-circuit-voltage oriented, and of a downward-moving microwave technology, which was based on power measurements in closed transmission lines of well-controlled impedance. At one time, low-frequency receivers commonly had high-impedance inputs designed for direct connection to the end of a capacitive antenna or to a high impedance open-wire line. Early lower-frequency signal generators had output impedances which were typically less than 10 ohms, so that their open-circuit output was also essentially the terminal voltage for receivers whose input impedance was usually many times higher. These older hf signal generators were generally calibrated in terms of their open-circuit output voltage, and their output-impedance specifications were often rather vague. On the other hand, the basic output calibration of even early microwave signal generators was in

terms of available power, expressed in dBm. The output impedance characteristics were generally specified even when they departed markedly from the ideal. These instruments also carried voltage scales, frequently on a matched-voltage basis (Equation 3) for which the conversion to available power by Equation 4 was obvious. Some microwave generators, such as the GR 1021 series, carried open-circuit voltage scales and dBm scales. In either event, available power was a reasonable basis for calibration of microwave receiver sensitivity because impedance matching to obtain optimum power transfer was facilitated by early standardization on a 50-ohm characteristic impedance for coaxial transmission lines.

Present Situation

With the passage of years, most lower-frequency, open-wire, high-impedance inputs have given way to shielded coaxial circuits designed around 50-ohm or 75-ohm impedance levels, and high-frequency signal-generator source impedances have been standardized at these same levels. At the same time, dBm scales have become widely accepted on hf signal generators as well as on microwave instruments. Unfortunately, there has never been satisfactory standardization of the method of output-voltage calibration; some hf and vhf signal generators are calibrated in terms of emf or open-circuit voltage, and others in terms of matched output voltage. The emf practice has remained prevalent in Europe, while the matched-output practice has been most common on generators specified and procured by the U.S. Department

of Defense; these procurements have had a major influence on calibration practices for commercial units as well.

Since both types of signal-generator-voltage calibration have existed in the U.S., the jargon of "hard" and "easy" microvolts has arisen among receiver designers. The term "hard" microvolts applies to the sensitivity measured by a generator with open-circuit calibration. This is because good sensitivity implies a small number of microvolts, clearly more difficult to achieve with this type of calibration. Conversely, sensitivities measured directly without correction, by use of a generator with matched-output voltage calibration, became known as "easy" microvolts. Most receiver test specifications require the use of "hard" microvolts, and the test procedures for use with *matched-output generators* call for insertion of a 6-dB pad at the generator output. The open-circuit voltage at the output of the pad is E_{LM} (Figure 2b), equal to the calibrated output voltage of the matched generator (Figure 2c). Thus the matched-output generator calibration can be read directly in cases where open-circuit values are desired. Direct reading of the dBm scale of a matched signal generator (without the extra 6-dB pad) gives a good measure of sensitivity for modern communication and navigation receivers that are designed for use with well-matched antennas and transmission lines. If the receiver input SWR is high so that it fails to accept the power available from the signal generator, the measured sensitivity suffers just as it would in practice when driven from a well-matched antenna. Since the dBm method of specification avoids the possible confusion of

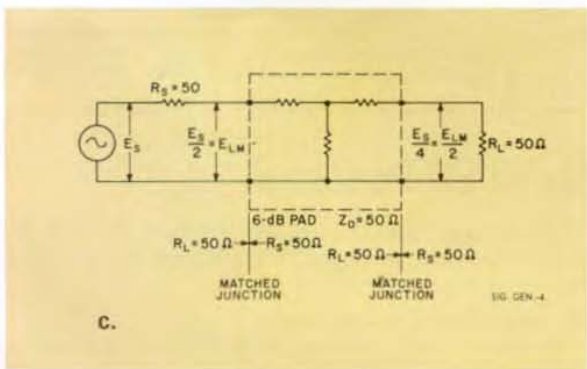
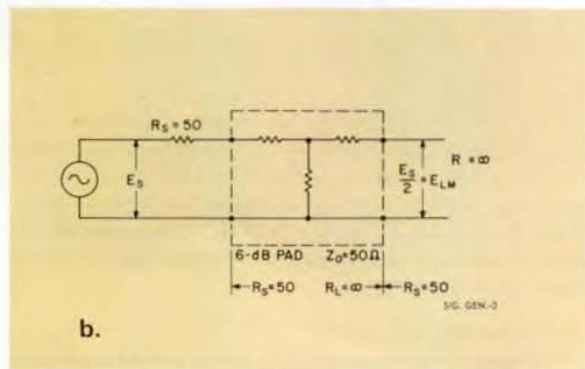
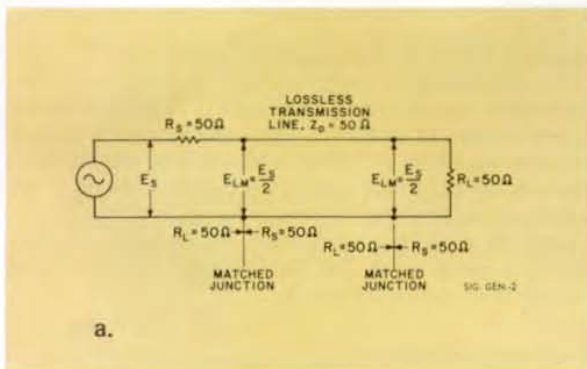

Figure 2. (a) Basic transmission system relationships; as modified (b) by insertion of 6-dB pad and (c) by addition of matching load.

necessary sync pulse to trigger the flash each time the shutter is fully open.

A high-speed camera is usually operated at framing rates several times the subject cyclic-motion rate, to obtain many pictures within a single cycle. It is possible, in the case of repetitive motions, to use a stroboscope and a conventional movie camera fitted with an appropriate synchronizing device to take movies at effective framing rates of hundreds of thousands of frames per second. In this case, a sampling technique is employed, similar in concept to the principle employed by a sampling oscilloscope, and each resulting image is of a different cycle. Figure 2a is an illustration of one of a number of techniques (outlined in the *Handbook of High-Speed Photography*) for using the stroboscope (whose "light is the high speed shutter") with a conventional movie camera, while Figure 2b is representative of the results obtainable. The Cinema-Beaulieu* camera in this example was chosen because it uniquely combines the features required of an instrumentation-grade camera, including provision for the addition of the required synchronizer for strobe use.

MONITORING QUALITY AT HIGH SPEED

In the graphic arts industry, stroboscopes play a vital role in maintaining printing quality. Today's high-speed presses print at the rate of 1000 feet per minute and faster. At these speeds, it is very important that any printing degradation, such as misregister or misalignment, be caught and corrected as soon as possible in order to minimize paper spoilage. This is particularly true when material such as computer business forms, labels, and recorder chart paper is printed on continuous paper strip. Tearing samples from a roll often is out of the question — even locating the fault is difficult because there is no way of determining how far into the roll the trouble may have gone. But, through the use of stroboscopy, printers are cutting operating costs drastically.

The printing is monitored with a stroboscope usually synchronized to the press, although photoelectric detection directly from the printed material is often practical with the GR 1540. The pressman views the stroboscopically stopped image. At the first sign of a misregister he inserts a paper "flag" into the printed roll where the fault begins, makes his press adjustments and inserts a second flag into the roll at the point where correct printing begins. Later, it is a simple matter to cut out the faults and to splice the rolls.

The modular construction of the GR 1540 makes it well suited to use on presses where the lamp head, operator controls, and power supply must be separated. Paper stretch and shrinkage during continuous printing also can be monitored with a stroboscope. A scale is permanently secured near the edge of the web so that reference can be made to some periodic printed mark on the paper. A reading of the scale is made with a strobe during press make-ready operations. The location of the printed mark with respect to the scale is then a fixed reference for proper operating conditions. This reference is viewed stroboscopically during the print run. If any deviation occurs, the press man knows immediately by how

*Cinema-Beaulieu, Inc., 155 West 68th Street, New York, N. Y., 10023.

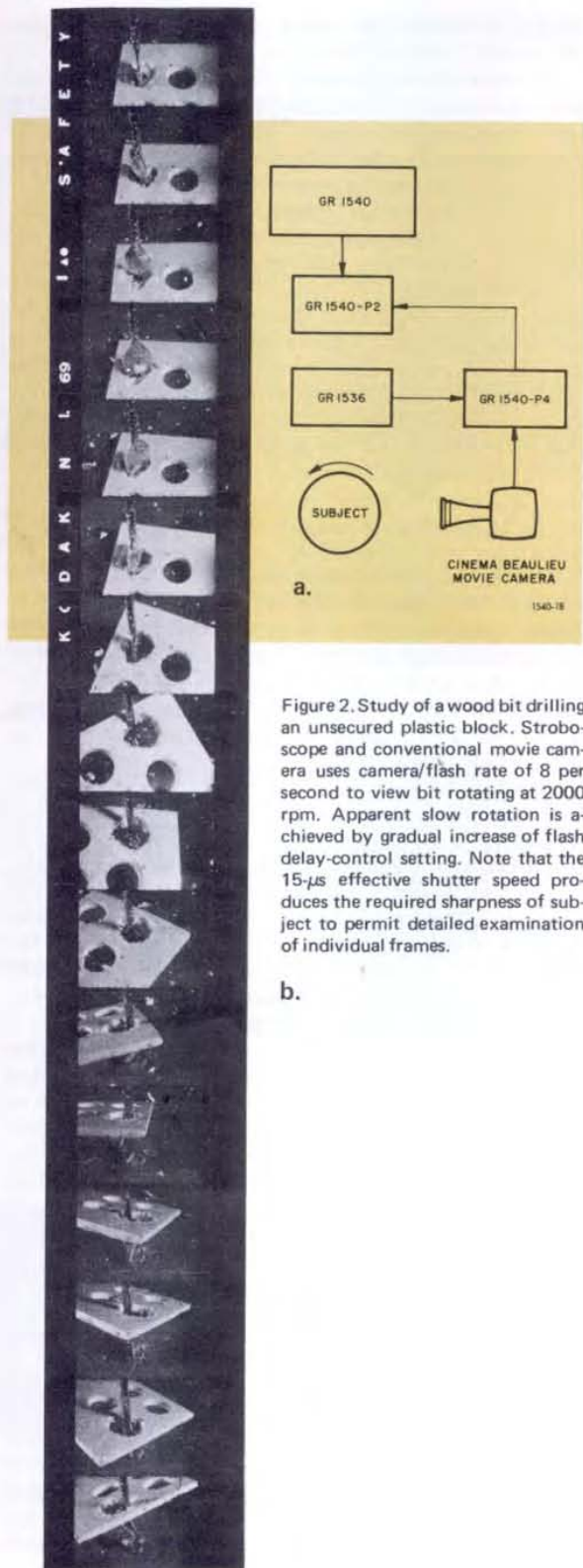

Figure 2. Study of a wood bit drilling an unsecured plastic block. Stroboscope and conventional movie camera uses camera/flash rate of 8 per second to view bit rotating at 2000 rpm. Apparent slow rotation is achieved by gradual increase of flash delay-control setting. Note that the 15- μ s effective shutter speed produces the required sharpness of subject to permit detailed examination of individual frames.

b.

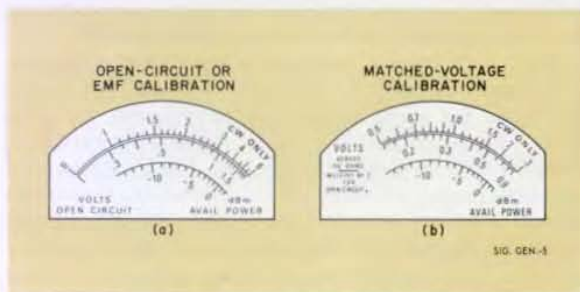

Figure 3. Old and new meter scales for GR 1003.

“hard” versus “easy” microvolts, it should be encouraged. Nevertheless, many sensitivity specifications still call for voltage calibrations, and one of the two types is generally provided on standard-signal generators.

For many years General Radio has supplied emf or open-circuit voltage calibrations. This is, in fact, the measured quantity at the monitoring or leveling point in most hf and vhf signal generators. Sensitivity measurements made with these calibrations correspond directly to the generally accepted “hard” microvolt type of specification. Calibration by use of open-circuit voltage is attractive for measurements on networks because this voltage is the effective Thévenin source voltage, independent of the length of line used to connect the generator to the network. There is the added advantage that the calibration remains unchanged if the signal-generator output impedance is increased from 50 to 75 ohms by the addition of a 25-ohm series resistor, but, of course, the dBm calibrations would no longer apply. In today’s age of specialization, any given organization is usually clearly oriented to either a 50-ohm or to a 75-ohm system. The 75-ohm system user prefers to buy a generator with consistent scale calibrations for his chosen impedance level. Thus, although for many applications open-circuit-voltage calibration appears logically attractive, increasingly widespread acceptance of matched-voltage calibration has led many of our customers to urge us to convert to the “volts-across” type of calibration.

New Instrument Calibrations

The original mechanical design of the output-attenuator dial mechanism in the GR 1003 and 1026 generators made conversion from one calibration system to the other uneconomical. New design features, however, have recently been introduced which allow us to change over quite readily. Current production of these two instruments now carries



G. P. McCouch joined General Radio in 1957, after working with the Harvard Radio Research Laboratory and Aircraft Radio Corporation. After receiving his AB in Physics from Harvard in 1941, he returned as a teaching fellow in 1947-48, to work toward his AM (1948). Presently he is Section Leader of the RF Oscillator Section. He is a senior member of IEEE and has held several offices in IEEE.

matched output or “volts-across-50-ohms” calibration; the older emf calibration is only available on special order. The dBm scales are, of course, unchanged. The meter scales are clearly marked to identify the new calibration and instruct the user to multiply by 2 for open-circuit volts. Alternatively, the user can add a 6-dB pad such as the GR 874-G6L to the output of the generator, thereby reducing its output by 2:1, so that the meter reads open-circuit voltage directly. The old and new meter scales for the GR 1003 Standard-Signal Generator are shown in Figure 3.

—G. P. McCouch

For Further Information

- Peterson, A. P. G., “Output Systems of Signal Generators,” *General Radio Experimenter*, June 1946.
- Moore, W. C., “Signal Generator and Receiver Impedance,” Boonton Radio Corp. *The Notebook*, No. 3, Fall 1954.
- Woods, D., “The Concept of Equivalent Source EMF and Equivalent Power in Signal Generator Calibration,” *Proceedings of the Institution of Electrical Engineers*, Part B, Paper 3356M, January 1961.

Recent Technical Articles by GR Personnel

“Computer-Controlled On-Line Testing and Inspection,” P. H. Goebel, 1969 *Wescon Technical Papers – Session 8*.*

“True RMS – The Digital Approach,” J.A. Lapointe, presented at the 77th Meeting of the Society of America, April 1969.**

“Versatile High-Speed One-Third Octave Band Analyzer,” W. R. Kundert, presented at the 77th Meeting of the Acoustical Society of America, April 1969.**

*Reprints available from General Radio.

**Included in article “New-Generation Acoustical Analyzer,” *GR Experimenter*, May/June 1969.

Damping Measurements of Resonance Bars

Researchers at Notre Dame University have approached the study of material damping capacity from the beginning, rather than the end. One of the most common procedures for measuring the internal friction of material is the resonance-bar technique, wherein a sample of the material to be studied is cut to the proper dimensions for resonance at some desired frequency in some specific mode of vibration. Damping is determined either with the specimen at resonance or in free decay from resonance. Dr. N. F. Fiore and R. M. Brach of Notre Dame have successfully developed a third variation of the technique in which the damping is determined by the relaxation time (τ_b), characterizing the rate at which the system *builds-up* to steady-state resonance vibration.

A disadvantage of both the steady-state and free-decay measurement approaches is the necessity to bring the material sample to steady-state resonance before the damping can be determined. In this circumstance, rapid physical changes can be taking place within the sample and be lost to the observer, because of the comparatively long time required to reach resonance and to begin serious observations. The approach described here permits the researcher to measure the damping decrement in thousandths of a second while the material sample is vibrated from rest to steady-state resonance.

The time taken by the vibrations of a specimen, under steady-state resonance conditions, to decay to e^{-1} of its maximum or steady-state amplitude, after removal of the driving forces, is designated as τ_d . The damping decrement δ is calculated from the relationship

$$\delta = (f_r \tau_d)^{-1}$$

in which f_r is the resonance frequency in hertz.

Conversely, the time (τ_b) for the amplitude of the driven system to reach $1 - e^{-1}$ of its steady-state value is approxi-

mately equal to τ_d . From this relationship the damping decrement can be redefined as

$$\delta = (f_r \tau_b)^{-1},$$

giving a faster and much simpler determination at the first stages of vibration at a time when the sample has been least affected by the driving force.

At steady-state condition, the decrement can be defined as

$$\delta = \frac{\pi(f_2 - f_1)}{f_r},$$

in which f_r is the resonance frequency and f_1 and f_2 are the frequencies at which the magnitude of vibration is 0.707 that at resonance.

The Notre Dame researchers first derived the mathematical relationships between the two methods, as described in the *Journal of the Acoustical Society of America*,¹ and then confirmed their calculations in a series of resonant-bar experiments. They used a Marx composite piezoelectric oscillator in which the input to the system is directly proportional to the input voltage across the driving transducer and the decrement is inversely proportional to the output voltage across a gaging transducer.

The circuit (Figure 1) used by Dr. Fiore and Brach employs two GR instruments, the GR 1162-A7C Coherent Decade Frequency Synthesizer and the GR 1396-B Tone-Burst Generator. The synthesizer generates a resonant frequency, at a controlled voltage, which feeds the tone-burst generator. The generator puts out a controlled pulse that

¹Fiore, N. F. and Brach, R. M., "Resonance-Bar Damping Measurements by the Resonance Build-up Technique," *Journal of the Acoustical Society of America* (in press).

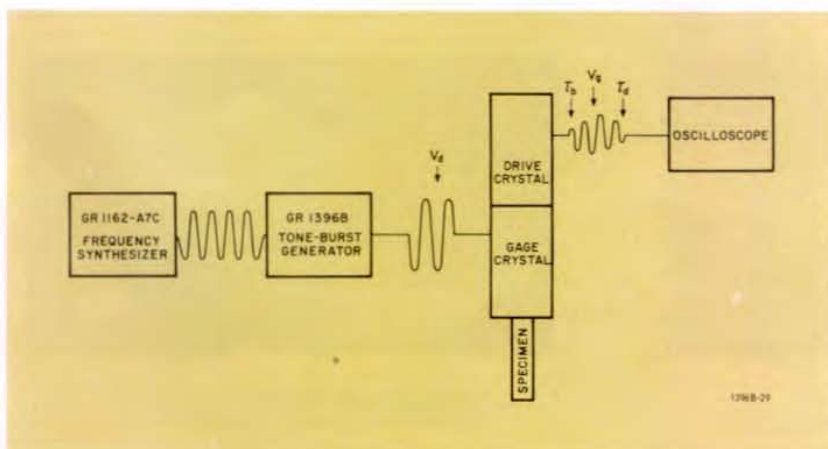

Figure 1. Block/schematic diagram of test equipment for resonance-bars experiments.

energizes the driver crystal; the vibrational magnitude increases from zero to the steady-state value. Resonance buildup is monitored on a storage oscilloscope, which displays the gage crystal output.

The method described above is unique in that it allows one to have his cake and to eat it too. As long as the pulse duration exceeds τ_b , the decrement can be determined directly from the relaxation time. When the pulse ends, the sample-rod driving force is zero; the vibrations and the gage-signal output decay to zero. From the oscilloscope display it is possible to obtain as many as three measurements of the decrement δ . During the time from rest to steady state at resonance, the decrement is defined by the build-up relation time τ_b . At steady state, δ is inversely proportional to the steady state amplitude. During the time from steady state to rest, δ is defined by τ_d . If high-speed measurements are required, the pulse duration can be made less than τ_d ; then τ_b can be derived by fitting an exponential curve to the approach envelope as displayed on the oscilloscope.

Figure 2 shows the oscilloscope trace for the quartz crystals alone, when driven by a 0.3-second burst in the longitudinal mode, at 50 kHz, and with constant applied

Condition	τ_b ms	τ_d ms	δ Buildup	δ Free Decay	δ Steady State
Marx Oscillator	44	49	4.4×10^{-4}	3.9×10^{-4}	3.6×10^{-4}
Marx plus Cu Crystal	2.4	2.5	8.1×10^{-3}	7.9×10^{-3}	8.4×10^{-3}

voltage of 1.8 V rms. Values for characteristic times, taken directly from the figure, give $\tau_b = 44$ ms and $\tau_d = 49$ ms. Values of the decrement as calculated for the three variations of the resonance-bar measurement technique are shown in Table 1.

Figure 3 shows the change in response brought about by mounting an annealed (111) copper single crystal upon the drive crystal and maintaining the applied voltage at 1.8 V rms.

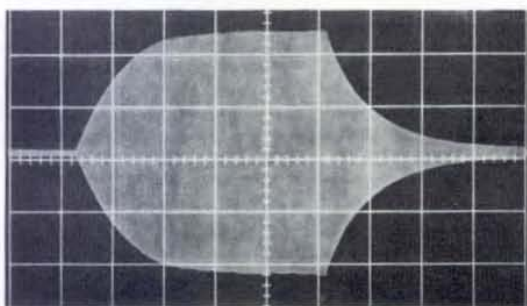

Figure 2. Oscilloscope picture of quartz-crystal response to 50-kHz burst (0.3 s) in longitudinal mode.



Dr. N. F. Fiore (left) is Associate Professor and Chairman, Department of Metal Engineering and Materials Science, University of Notre Dame. He is a graduate of Carnegie Institute of Technology and holds degrees of BS, MS and PhD in Metallurgical Engineering.

Dr. R. M. Brach (right) is Associate Professor, Department of Aerospace and Mechanical Engineering, University of Notre Dame. He holds degrees of BS and MS from the Illinois Institute of Technology and received his PhD in Engineering Mechanics from the University of Wisconsin.

The large increase in damping causes rapid attainment of steady-state resonance and rapid decay to zero after completion of the tone burst. Calculated values for the decrement, derived by the three variations in technique, are shown in Table 1.

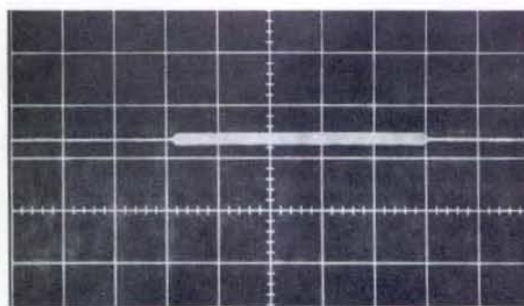

Figure 3. Change in response of quartz crystal by addition of annealed copper single crystal.

Reports from the Field

FROM THE FAR NORTH

The Kongsfjord Telemetry Station in Spitzbergen, Norway operates as an observation and data-collection point for the European Space Research Organization (ESRO) in addition to handling its routine tasks for the Norwegian government. Engineer Bjorn Myrstad reports that the GR 1163-A4 Coherent Decade Frequency Synthesizer is an integral part of the station's system. It supplies 100-kHz signals for modulation of a test generator and controls three other signals – the telemetry transmitter's second and first local-oscillator frequencies and a test-generator operating frequency.

ESRO is geared for an extensive satellite launch program. Six satellites are scheduled for launch in the next six years, to participate in scientific experiments including cosmic-ray studies. The last satellite is scheduled for launch into a stationary orbit and will contain ten experiments controlled by several European countries.

The photograph contributed by Mr. Myrstad shows the GR synthesizer, upper right, part of the station's system supplied by the Sud Aviation Company.

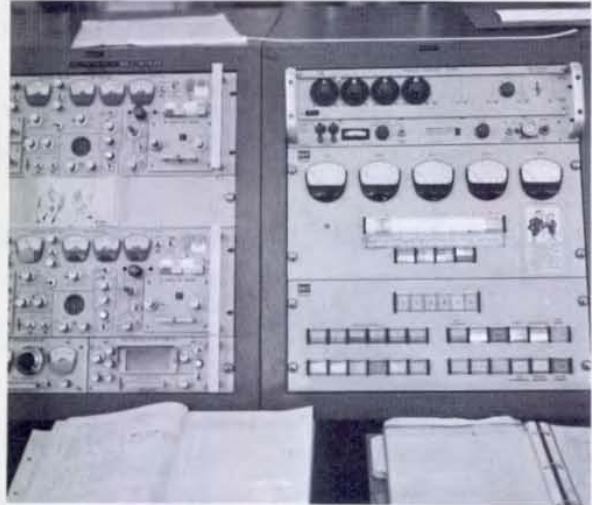

NEW



Complete conversion of the GR 1310-B Oscillator to solid-state circuitry has not altered the outer appearance of this familiar oscillator. It has, however, enabled GR to lower the price, making the instrument even more attractive to users.

Specifications for the GR 1310-B are the same as for the GR 1310-A in GR catalog T, except for accuracy ($\pm 3\%$ of setting) and price.

Catalog Number	Description	Price in USA
1310-9702	1310-B Oscillator (Specify 115-, 220-, or 230-V line operation)	\$275.00
1560-9695	1560-P95 Adaptor Cable	3.00
0480-9838	480-P308 Rack-Adaptor Set	10.00

All prices subject to quantity discount.

GENERAL RADIO

WEST CONCORD, MASSACHUSETTS 01781
617 369-4400

SALES AND SERVICE

ALBUQUERQUE	505 265-1099	DENVER	303 447-9225	*NEW YORK (NY)	212 964-2722
ATLANTA	404 633-6183	DETROIT	313 261-1750	(NJ)	201 943-3140
BOSTON	617 646-0550	GREENSBORO	919 288-4316	PHILADELPHIA	215 646-8030
BRIDGEPORT	203 377-0165	GROTON	203 445-8445	ROCHESTER	315 394-2037
BURBANK	213 899-2644	HARTFORD	203 658-2496	SAN DIEGO	714 540-9830
*CHICAGO	312 992-0800	HOUSTON	713 464-5112	*SAN FRANCISCO	415 948-8233
CLEVELAND	216 886-0150	HUNTSVILLE	800 241-5122	SEATTLE	206 747-9190
COCOA BEACH	800 241-5122	INDIANAPOLIS	317 636-3907	SYRACUSE	315 454-9323
*DALLAS	214 637-2240	*LOS ANGELES	714 540-9830	*WASHINGTON, BALTIMORE	301 881-5333
DAYTON	513 434-6979				

INTERNATIONAL DIVISION

WEST CONCORD, MASSACHUSETTS 01781, USA

ARGENTINE and PARAGUAY

Coasin S. A.
Buenos Aires

AUSTRALIA

Warburton Franki Industries
Pty. Ltd.
Sydney, Melbourne,
Brisbane, Adelaide

BRAZIL

Ambriex S. A.
Rio de Janeiro GB
Sao Paulo, S. P.

CANADA

*General Radio Canada Limited
Toronto,
Montreal, Ottawa

CHILE

Coasin Chile Ltda.
Santiago

COLOMBIA

Manuel Trujillo
Venegas e Hijo, Ltda.
Bogota 2, D. E.

DEMOCRATIC REPUBLIC OF THE CONGO

Rudolph-Desco Co., Inc.
New York

HONG KONG and MACAU

Gilman & Co., Ltd.
Hong Kong, B. C. C.

INDIA

Motwane Private Limited
Bombay, Calcutta, Lucknow,
Kanpur, New Delhi,
Bangalore, Madras

JAPAN

Midoriya Electric Co., Ltd.
Tokyo

KOREA

M-C International
San Francisco,
Seoul

MALAYSIA

Vanguard Company
Kuala Lumpur

MEXICO

Electronia Fredin S. A.
Mexico, 10 D. F.

NEW ZEALAND

W. & K. McLean Limited
Auckland

PAKISTAN

Pakland Corporation
Karachi

PERU

Importaciones y
Representaciones
Electronicas S. A.
Lima

PHILIPPINES

T. J. Wolff & Company
Makati, Rizal

REPUBLIC OF SOUTH AFRICA

G. H. Langler & Co., Ltd.
Johannesburg

SINGAPORE

Vanguard Company
Singapore

TAIWAN

Haighen Trading Co., Ltd.
Taipei

THAILAND

G. Simon Radio Company
Ltd.
Bangkok

TURKEY

Mevag Engineering, Trading
and Industrial Corporation
Istanbul

URUGUAY

Coasin Uruguay S. A.
Montevideo

VENEZUELA

Coasin C. A.
Caracas

*GENERAL RADIO COMPANY (OVERSEAS)

Helenastrasse 3, CH-8034, Zürich 34, Switzerland

AUSTRIA

Dipl. Ing. Peter Marchetti
Wien

BELGIUM

Groenpol-Belgique S. A.
Bruxelles

DENMARK

SEMCO Semler & Co.
København Ø

EIRE

General Radio Company
(Overseas)
General Radio Company
(U.K.) Limited

FINLAND

Into O/Y
Helsinki

FRANCE

General Radio France
Paris, Lyon

GERMANY

General Radio GmbH
München
Norddeutsche Vertretung
Dr. Ing. Nüsslein
Wedel

GREECE

Marios Dalleggio
Athens

ISRAEL

Eastronics Ltd.
Tel Aviv

ITALY

General Radio Italia S.p.A.
Milano

NETHERLANDS

Groenpol Groep Verkoop
Amsterdam

NORWAY

Gustav A. Ring A/S
Oslo

PORTUGAL and SPAIN

General Radio Company
(Overseas)

SWEDEN

Firma Johan Lagercrantz KB
Sölna

SWITZERLAND

Seyffer & Co. AG
Zürich

*UNITED KINGDOM

*General Radio Company
(U.K.) Limited
Bourne End,
Buckinghamshire

YUGOSLAVIA

Sanford de Brun
Wien, Österreich

*Repair services are available at these offices.

GENERAL RADIO

Experimenter

WEST CONCORD, MASSACHUSETTS 01781

Do we have your correct name and address—name, company or organization, department, street or P.O. box, city, state, and zip code? If not, please clip the address label on this issue and return it to us with corrections or, if you prefer, write us; a postcard will do.

PRINTED
IN U.S.A.



IET LABS, INC in the GenRad tradition
534 Main Street, Westbury, NY 11590

www.ietlabs.com
TEL: (516) 334-5959 • (800) 899-8438 • FAX: (516) 334-5988