

**Model 1232-A**  
**-AP Tuned Amplifier**  
**and**  
**Null Detector**  
**User and Service Manual**



Copyright © 2005 IET Labs, Inc.

1232-A im/June 2005



**IET LABS, INC.**  
formerly manufacturer by  
**GenRad**

Long Island, NY • Email: [info@ietlabs.com](mailto:info@ietlabs.com) [www.ietlabs.com](http://www.ietlabs.com)  
TEL: (516) 334-5959 • (800) 899-8438 • FAX: (516) 334-5988

◆ PRECISION INSTRUMENTS FOR TEST AND MEASUREMENT ◆



---

**IET LABS, INC.**

Long Island, NY • Email: [info@ietlabs.com](mailto:info@ietlabs.com)

[www.ietlabs.com](http://www.ietlabs.com)

TEL: (516) 334-5959 • (800) 899-8438 • FAX: (516) 334-5988

## **WARRANTY**

We warrant that this product is free from defects in material and workmanship and, when properly used, will perform in accordance with applicable IET specifications. If within one year after original shipment, it is found not to meet this standard, it will be repaired or, at the option of IET, replaced at no charge when returned to IET. Changes in this product not approved by IET or application of voltages or currents greater than those allowed by the specifications shall void this warranty. IET shall not be liable for any indirect, special, or consequential damages, even if notice has been given to the possibility of such damages.

THIS WARRANTY IS IN LIEU OF ALL OTHER WARRANTIES, EXPRESSED OR IMPLIED, INCLUDING BUT NOT LIMITED TO, ANY IMPLIED WARRANTY OF MERCHANTABILITY OR FITNESS FOR ANY PARTICULAR PURPOSE.



## WARNING



OBSERVE ALL SAFETY RULES  
WHEN WORKING WITH HIGH VOLTAGES OR LINE VOLTAGES.

**Dangerous voltages may be present inside this instrument. Do not open the case  
Refer servicing to qualified personnel**

### **HIGH VOLTAGES MAY BE PRESENT AT THE TERMINALS OF THIS INSTRUMENT**

WHENEVER HAZARDOUS VOLTAGES (> 45 V) ARE USED, TAKE ALL MEASURES TO  
AVOID ACCIDENTAL CONTACT WITH ANY LIVE COMPONENTS.

USE MAXIMUM INSULATION AND MINIMIZE THE USE OF BARE  
CONDUCTORS WHEN USING THIS INSTRUMENT.

**Use extreme caution when working with bare conductors or bus bars.**

WHEN WORKING WITH HIGH VOLTAGES, POST WARNING SIGNS AND  
KEEP UNREQUIRED PERSONNEL SAFELY AWAY.



## CAUTION



DO NOT APPLY ANY VOLTAGES OR CURRENTS TO THE TERMINALS OF THIS  
INSTRUMENT IN EXCESS OF THE MAXIMUM LIMITS INDICATED ON  
THE FRONT PANEL OR THE OPERATING GUIDE LABEL.

---

# Contents

---

## Section 1 INTRODUCTION

1.1 Purpose . . . . .	1
1.2 Description . . . . .	1
1.3 Controls and Connectors . . . . .	2
1.4 Use of External Filters . . . . .	2

## Section 2 PRINCIPLES OF OPERATION

2.1 Preamplifier of the Type 1232-A . . . . .	3
2.2 Frequency Selective Amplifier . . . . .	4
2.3 Null Network . . . . .	4
2.4 Amplifier-Compressor . . . . .	5
2.5 Meter Circuit . . . . .	5

## Section 3 OPERATION

3.1 Use as an Amplifier or Preamplifier . . . . .	6
---	---

3.2 Use as a Null Detector for Bridge Balancing . . . . .	6
3.3 Use in Audio Spectrum Analysis . . . . .	7

## Section 4 SERVICE AND MAINTENANCE

4.1 GR Field Service . . . . .	8
4.2 Removal of Cover . . . . .	8
4.3 Battery Installation . . . . .	8
4.4 Internal Noise . . . . .	9
4.5 Transistor Voltage and Resistance Measurements . . . . .	10
4.6 Trimmer-Capacitor Adjustment . . . . .	10
4.7 Minimum Performance Standards . . . . .	11
4.8 Knobs . . . . .	16

---

## Instruction Manual Changes

---

### Specifications, Page iii

Power: Nine mercury cells in series have been replaced by eight "AA" alkaline batteries, manufacturers part number:

Everready E91  
Duracell MN1500  
Ray-O-Vac B15

Estimated battery life is 250 hours.

### Service and Maintenance, Paragraph 4.3, Battery Installation, Page 8

Remove the instrument cover per paragraph 4.2, Removal of Cover.

Remove the old batteries and replace with eight new ones, installed per polarity marking.

### Electrical Parts List, Page 20

Nine mercury cells have been replaced by eight "AA" alkaline batteries, manufacturers part number listed above.

# Specifications

## TYPE 1232-A TUNED AMPLIFIER AND NULL DETECTOR

**Frequency Response:** TUNABLE FILTERS: 20 Hz to 20 kHz in 3 ranges; between 2% and 6% bandwidth to 15 kHz; 2nd harmonic at least 34 dB down from peak, 3rd at least 40 dB down; rejection filter on two highest ranges reduces 60-Hz level to at least 60 dB below peak response (50-Hz level is down >50 dB). Dial accuracy is  $\pm 3\%$ . FIXED-TUNED FILTERS: 50 kHz, 2nd harmonic is 44 dB down; 100 kHz . . . 53 dB down. FLAT RESPONSE:  $\pm 3$  dB from 20 Hz to 100 kHz.

**Sensitivity:** See plot. Typically better than  $0.1 \mu\text{V}$  over most of the frequency range.

**Noise Level:** REFERRED TO INPUT: See plot. Noise figure at 1 kHz is less than 2 dB at an optimum source impedance of  $27 \text{ k}\Omega$ . REFERRED TO OUTPUT: Less than 5 mV on FLAT filter-frequency position, min gain setting, and  $-20$ -dB switch position; less than 50 mV in MAX SENS position.

**Input:** IMPEDANCE: Approx  $50 \text{ k}\Omega$  at max gain; varies inversely with gain to  $1 \text{ M}\Omega$  at min gain. MAX SAFE VOLTAGE: 200 V ac or 400 V dc.

**Output:** VOLTAGE GAIN: Approx 120 dB on the tunable ranges; 100 dB, flat range; 106 dB at 50 kHz; 100 dB at 100-kHz position. LEVEL: 1 V into  $10 \text{ k}\Omega$  when meter indication is full scale. INTERNAL IMPEDANCE:  $3 \text{ k}\Omega$ . METER LINEARITY: dB differences are accurate to  $\pm 5\% \pm 0.1$  division for inputs of less than 0.3 V. COMPRESSION (meter switch to LOG): Reduces fullscale sensitivity by 40 dB. Does not affect bottom 20% of scale. ATTENUATION (meter switched to  $-20$  dB): Linear response with 20-dB less gain than MAX SENS.

**Distortion** (filter switch in FLAT position):  $< 5\%$  (due to meter rectifiers).

**Terminals:** Input, GR874<sup>®</sup> coaxial connector; output, binding posts.

**Available:** 1232-P2 Preamp to maintain sensitivity of 1232-A at low frequencies when operating from a source impedance above  $100 \text{ k}\Omega$ ; rack-adaptor sets (see below) convert 1232 alone, or with companion instruments, to 19-in. rack-mount width.

**Power:** 12 V dc; from 9 mercury (M72) cells in series. Est battery life 1500 hours.

Optionally, a rechargeable battery (non-mercury) can be supplied on special order.

**Mechanical:** Convertible bench cabinet. DIMENSIONS (wxhxd): Bench,  $8 \times 6 \times 7.5$  in. ( $203 \times 152 \times 190$  mm). WEIGHT: 5.75 lb (2.6 kg) net, 8 lb (3.7 kg) shipping.

Description	Catalog Number
<b>1232-A Tuned Amplifier and Null Detector</b>	<b>1232-9701</b>
<b>1232-AP Tuned Amplifier and Null Detector</b> , with preamplifier	<b>1232-9829</b>
<b>Rack-Adaptor Sets</b>	
<b>480-P308</b> , for 1232-A alone	<b>0480-9838</b>
<b>480-P316</b> , for 1232-A with 1310 or 1311 oscillator or similar 8-in. wide instrument with convertible-bench cabinet	<b>0480-9836</b>
<b>480-P317</b> , for 1232-AP (with preamp) and companion 8-in. instrument	<b>0480-9837</b>
<b>Replacement Battery</b> , 9 req'd	<b>8410-1372</b>

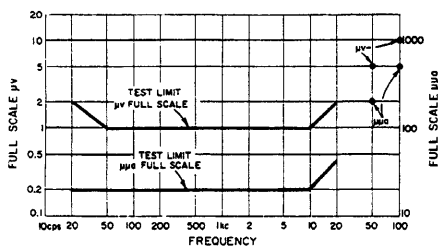

*Minimum input for full-scale meter deflection as a function of frequency.*

## SPECIFICATIONS (cont)

### TYPE 1232-P2 PREAMPLIFIER

(Accessory supplied with Type 1232-AP and Type 1240-AP only)

**Voltage Gain:** Approx 0.7.

**Noise (referred to input):** Open-circuit equivalent 0.1 pA; short-circuit equivalent, 0.3  $\mu$ V (when used with Type 1232-A tuned to 100 Hz).

**Impedances:** INPUT: >100 m $\Omega$  in parallel with 70 pF. OPTIMUM SOURCE: 3 M $\Omega$ .  
OUTPUT: 10 k $\Omega$ .

**Connectors:** GR874<sup>®</sup> on cables, input and output.

**Power:** 12 V, 200  $\mu$ A, supplied by 1232-A.

**Mechanical:** Special cabinet. DIMENSIONS (wxhxd): 0.75x6x7.5 in. (19x152x190 mm).  
WEIGHT: 0.94 lb (0.43 kg) net, 4 lb (1.9 kg) shipping.

Description	Catalog Number
1232-P2 Preamplifier	1232-9602

### TYPE 1240-A, -AP BRIDGE OSCILLATOR-DETECTORS

The Type 1240-A Bridge Oscillator-Detector is a rigid assembly of a Type 1311 Audio Oscillator and a Type 1232 Tuned Amplifier and Null Detector. The Type 1240-AP includes the Type 1232-P2 Preamplifier in addition to the above instruments. These compact assemblies are convenient for use with audio-frequency bridges and other null-balance devices.

The units are secured with an Adaptor Plate Set (P/N 0480-9836 for 1240-A, 0480-9837 for 1240-AP) and bolted together near the rear of the instruments. The assembly fits a standard 19-inch relay rack. For bench use, the two wings of the relay-rack adaptor set can be removed and the four rubber feet can be installed in the corners of the oscillator-detector assembly.

Operating instructions for the Type 1232-A or -AP Tuned Amplifier and Null Detector are given in this book. A separate instruction book is supplied for the Type 1311 Audio Oscillator.

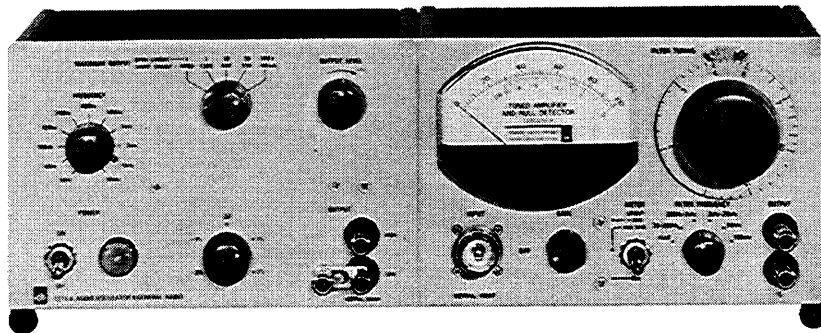

*GR 1240-A Bridge Oscillator-Detector.*





---

# Introduction—Section 1

---

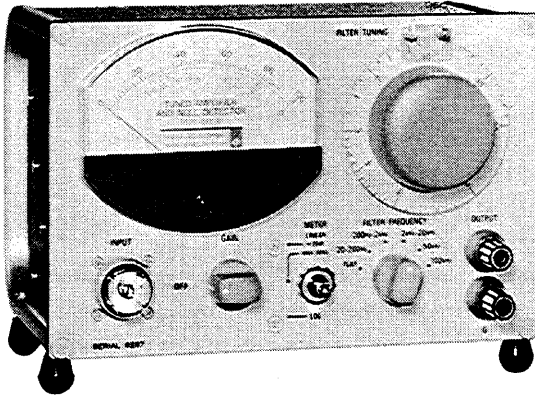

Figure 1. Type 1232-A Tuned Amplifier and Null Detector.

## 1.1 PURPOSE

The Type 1232-A Tuned Amplifier and Null Detector (Figure 1) is a sensitive, low-noise amplifier continuously tunable from 20 Hz to 20 kHz, with additional fixed-tuned frequencies of 50 kHz and 100 kHz. Intended primarily as a bridge detector, the Type 1232-A can also be used as a detector of high-frequency modulated signals (with a crystal demodulator), a wave analyzer at audio frequencies, and a preamplifier for transducers.

The Type 1232-P2 Preamplifier can be added to improve the signal-to-noise ratio and consequently the effective sensitivity of the Type 1232-A when the latter is to be driven by very high (greater than 100 k $\Omega$ ) impedance sources.

## 1.2 DESCRIPTION

The Type 1232-A consists of a low-noise preamplifier, a frequency-selective stage (feedback amplifier and null network), an amplifier-compressor stage, and a meter-rectifier circuit (see block diagram, Figure 2). The total gain of the amplifier is about 120 dB. Full-scale meter sensitivity is 1 microvolt or better over most of the frequency range.

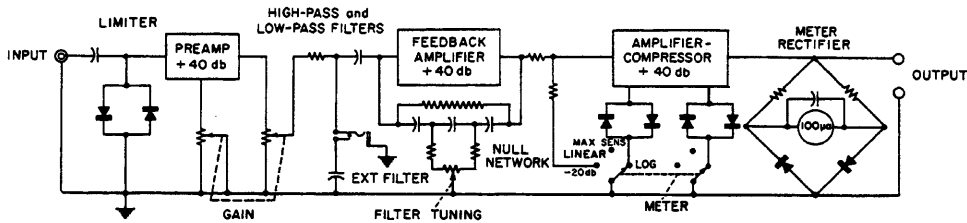

Figure 2. Functional diagram of the null detector.

With the Type 1632 Inductance Bridge, this null detector permits inductance balances to a resolution of 1 part in  $10^6$ . Comparable precision for capacitance balance can be obtained with the Type 1615 and 716 Capacitance Bridges.

The amplifier is powered by 12 Vdc, supplied by nine mercury batteries in series. The output is 1 V into 10,000 ohms.

Front mountings are extendible to tilt instrument face.

The Type 1232-P2 Preamplifier is a detachable accessory that consists of a low-noise field-effect transistor used in common-source configuration. Power for the preamp is provided by the B + supply of the Type 1232-A.

### 1.3 CONTROLS AND CONNECTORS OF THE TYPES 1232 AND 1232-P2.

TABLE 1

	<i>Name</i>	<i>Type</i>	<i>Function</i>
Type 1232	FILTER TUNING	Continuous rotary control	Tunes filter within selected tuning range.
	FILTER FREQUENCY	6-position rotary switch	Selects desired frequency characteristic; tuning-frequency range of 20-200 Hz, 200 Hz-2 kHz, or 2-20 kHz; flat, 50-kHz or 100-kHz response.
	GAIN	Rotary control	Turns instrument on or off and controls gain.
	METER	3-position toggle switch	Selects full-gain linear, -20-dB linear, or logarithmic response.
	INPUT	GR874 Locking Coaxial Connector	Input terminals.
	OUTPUT	Pair of Type 938 Binding Posts	Output terminals.
	EXTERNAL FILTER	Phone jack	Connection for external filter.
Type 1232-P2	HIGH Z, LOW Z	Toggle switch	Determines whether Preamplifier is included in input to Type 1232 (HIGH Z) or shunted (LOW Z).
	INPUT	GR874 Connector and Cable Assembly	Input terminals.
	OUTPUT	GR874 Connector and Cable Assembly	Output terminals (to be applied to INPUT of Type 1232).

### 1.4 USE OF EXTERNAL FILTERS.

Filters can be connected at the EXTERNAL FILTER jack. When a telephone plug is inserted in this jack, the built-in shunt filter is disconnected. The external filter may be either a series-tuned circuit to trap out an undesired frequency or an antiresonant parallel-tuned circuit to improve the selectivity at the desired frequency. For the purpose of calculating the Q of the external filter, the source impedance is about 700 ohms. Since the external filter is plugged into the circuit at a point beyond the 60-Hz rejection filter and where there is 80-dB gain to the meter circuit, it is important that the external filter be shielded and preferably that it use a toroidal inductor for minimum sensitivity to hum pickup.

---

# Principles of Operation—Section 2

---

## 2.1 PREAMPLIFIER OF THE TYPE 1232-A.

The preamplifier stage of the Type 1232-A Tuned Amplifier and Null Detector is designed to minimize noise from both low-impedance sources, such as inductance bridges at low frequencies, and high-impedance sources, such as capacitance bridges at low frequencies. A transistor with a noise figure of 3 to 5 dB at an optimum source impedance of 50 kilohms is used. By use of negative feedback, the input impedance of the preamplifier is also made 50 kilohms, and the noise level indicated on the output meter is relatively constant and independent of source impedance.

The input transistor is protected from possible damage due to large overloads by a limiter consisting of a series capacitor and two shunt silicon rectifier diodes. This circuit effectively prevents signals greater than 1 volt, peak-to-peak, from reaching the input transistor and does not contribute noise or distortion to low-level signals.

Maximum gain of the preamplifier is about 40 dB, which is adequate to swamp the noise of succeeding stages. After preamplification, the signal passes through a set of series and shunt filters, which are designed to reject frequencies above and below the selected tuning range. Typical filter characteristics are shown in Figure 3. On all switch positions except FLAT and 20 – 200 Hz, another rejection filter reduces the response at 60 Hz to greater than 60 dB below peak response.

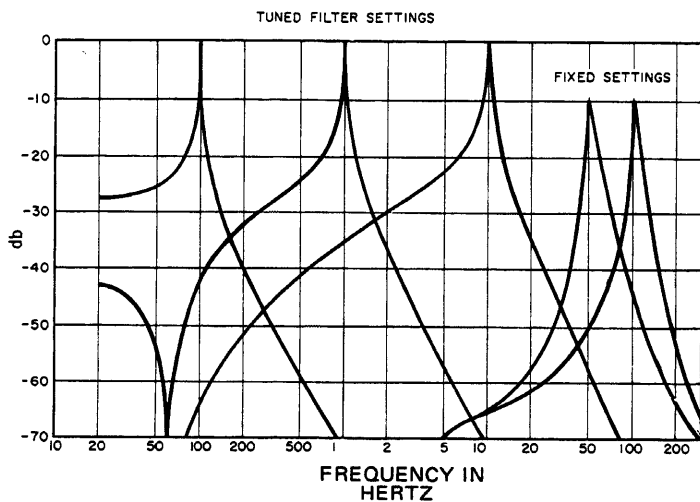

Figure 3. Typical filter characteristics of the Type 1232-A.

## 2.2 FREQUENCY-SELECTIVE AMPLIFIER.

This amplifier consists of three stages with negative feedback through a null network, which has its null at the desired operating frequency. Since there is negative feedback at all frequencies but the desired one, the over-all response peaks at this frequency and is roughly equivalent to that of a tuned circuit with a Q of about 20 (5% bandwidth). The unique feature of this null network is its one-potentiometer tuning. Many null networks require three variable elements, either ganged capacitors or ganged potentiometers. This leads to many problems in alignment and tracking the three elements to maintain a good null. The Hall null network has a perfect null in theory for any position of the tuning potentiometer, and it is possible to cover a 10:1 tuning range with a 40-dB exponential potentiometer. Tuning capacitors are switched to change ranges, maintaining the impedance level of the null network approximately constant for the three tuning ranges.

Since the 50-kHz and 100-kHz null networks need not be tunable, conventional twin-T null networks are used.

On the FLAT position of the range switch, all filters are switched out and the frequency response is flat to within  $\pm 3$  dB from 20 Hz to 100 kHz. The over-all gain of the amplifier is reduced by 26 dB to keep the noise level on the output meter equal to about 10 percent of full scale at maximum gain.

## 2.3 NULL NETWORK.

The Type 1232-A Tuned Amplifier and Null Detector uses an RC null network with only one variable component to adjust the frequency of the null. This avoids the use of ganged variable components, which must track closely to maintain stability when used in highly selective feedback amplifiers. The network (Figure 4), consisting of three-terminal RC circuits, gives a complete null without being balanced against a voltage divider, and permits frequency adjustment with a single potentiometer. The tuning law for this circuit is

$$\omega_0 = \frac{.1}{RC \sqrt{\alpha(1-\alpha)(1+2k)}}$$

In order to span a 10-to-1 logarithmic frequency range, the potentiometer must have an exponential characteristic of over 100 to 1.

The selectivity of the transfer admittance,  $\frac{I_o}{E_{in}}$  (or  $y_{21}$ ) is quite constant

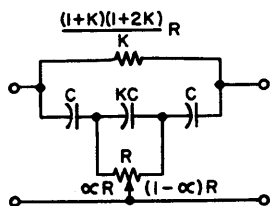

Figure 4. Null circuit of the Type 1232-A Tuned Amplifier and Null Detector.

as the null frequency is changed. In order to use this characteristic, the network must be driven by and loaded by low impedances. Therefore, it is used in a feedback circuit with an amplifier having low input and output impedances and a transfer resistance  $\frac{E_o}{I_{in}}$  (or a real  $z_{21}$ ) that is chosen to give the desired selectivity. This combination provides a second-harmonic rejection of 34 dB over each 10-to-1 frequency range.

#### **2.4 AMPLIFIER-COMPRESSOR.**

With the METER switch set to either linear position, the amplifier-compressor functions as a linear amplifier, driving the meter rectifier circuit and supplying the output terminals with about 1.4 V for full-scale deflection of the meter. The MAX SENS position provides full gain for very low-level applications. When maximum sensitivity is not required, use the LINEAR — 20 dB position for a less noisy output. With this switch setting, the noise generated in the input and selective amplifier stages is attenuated. The dc supplied to the last transistor is sufficient to drive the output meter to full scale, but very little more, so that it is impossible to damage the meter by overdriving the amplifier.

For null detector use, the METER switch is thrown to LOG, effectively compressing the upper part of the meter scale. Two pairs of silicon diodes are switched in shunt with the collector resistors of two transistors to provide a nonlinear collector impedance. Owing to the voltage offset of the silicon diodes, the bottom 20 percent of the meter scale is virtually unaffected. A signal level corresponding to 100 percent deflection for linear response will drop to 50 percent for logarithmic response. An increase of 20 dB increases the reading to 80 percent, and another 20 dB raises the reading to 100 percent.

#### **2.5 METER CIRCUIT.**

The meter circuit uses a full-wave rectifier in order to double the ripple frequency that passes through the meter and thus to prevent the needle from vibrating visibly at 20 Hz. Resistors are used in place of two of the rectifiers in the conventional full-wave bridge in order to linearize the relation between meter indication and signal level, and to minimize distortion. No dc amplification was incorporated into the meter circuit, so that there is no need for a dc zero adjustment on the front panel and no possibility of dc zero instability. High-impedance, crystal-type earphones can be connected to the output terminals.

---

# Operation – Section 3

---

## 3.1 USE AS AN AMPLIFIER OR PREAMPLIFIER.

To use the Type 1232-A or -AP Tuned Amplifier and Null Detector as an amplifier:

a. Connect the input signal to the INPUT connector of the Type 1232 or, if used, the Type 1232-P2. Adaptors for connectors other than Type 874 are available from General Radio. If the output impedance of the source of this signal is greater than  $100\text{ k}\Omega$ , set the switch on the Type 1232-P2, if used, to HIGH Z; otherwise set the switch to LOW Z.

### NOTE

For connection to binding posts, use a Type 874-R34 Patch Cord. (Hum pickup is too great with a Type 874-Q2 Adaptor.)

b. Set the METER switch to LINEAR  $-20\text{ dB}$  (unless maximum sensitivity is required.)

c. Set the FILTER FREQUENCY switch for the desired characteristic: FLAT, 20-200 Hz, 200 Hz – 2 kHz, 2-20 kHz, 50 kHz, or 100 kHz.

d. With the GAIN control, turn the instrument on and adjust the gain to the desired level. The total range of the GAIN control is 120 dB, and attenuation in dB is roughly proportional to the rotation angle of the control knob.

e. The OUTPUT terminals may be connected to an oscilloscope or headphones. The red binding post is high, the black binding post is ground.

The high sensitivity of this instrument permits its use as a preamplifier for transducer outputs or oscilloscope input.

## 3.2 USE AS A NULL DETECTOR FOR BRIDGE BALANCING.

To use this instrument as a detector for bridge measurements;

a. Connect the INPUT terminals of the Type 1232-A or -AP to the DETECTOR terminals of the bridge as in paragraph 3.1, step a.

b. Set the METER switch to LOG.

c. Set the FILTER FREQUENCY and FILTER TUNING controls to the desired frequency.

d. With generator and unknown connected to the bridge, set the GAIN control of the Type 1232-A for approximately half-scale deflection of the output meter, and tune the FILTER TUNING control for maximum output.

The bridge balance can now be made in the conventional manner, by re-adjustment of the GAIN control as balance is approached.

### 3.3 USE IN AUDIO SPECTRUM ANALYSIS.

The tuned amplifier can be used as an audio-frequency wave analyzer with a sensitivity of  $1 \mu\text{V}$  and a bandwidth of about 5 percent. For approximate measurements, the gain can be assumed to be constant with frequency. More accurate measurements can be obtained if the amplifier is first calibrated with a constant-amplitude, variable-frequency signal. The typical variation of peak response vs frequency is shown in Figure 5.

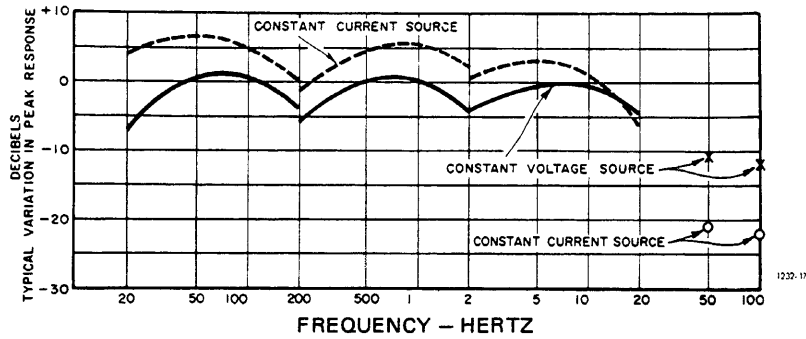

Figure 5. Typical variation in peak response with frequency for constant gain-control setting.

---

# Service and Maintenance—Section 4

---

## 4.1 GR FIELD SERVICE.

Our warranty attests the quality of materials and workmanship in our products. When difficulties do occur, our service engineers will assist in any way possible. If the difficulty cannot be eliminated by use of the following service instructions, please write or phone the nearest GR service facility (see back page), giving full information of the trouble and of steps taken to remedy it. Describe the instrument by type, serial, and ID numbers. (Refer to front and rear panels.)

Before returning an instrument to General Radio for service, please ask our nearest office for a "Returned Material" number. Use of this number in correspondence and on a tag tied to the instrument will ensure proper handling and identification. After the initial warranty period, please avoid unnecessary delay by indicating how payment will be made, i.e., send a purchase-order number or (for transportation charges) request "C.O.D."

For return shipment, please use packaging that is adequate to protect the instrument from damage, i.e., equivalent to the original packaging. Advice may be obtained from any GR office.

## 4.2 REMOVAL OF COVER.

To open the instrument for access to transistors and components, loosen the two fluted captive screws at the rear of the instrument and slide the U-shaped dust cover away from the panel. All transistors and components are now accessible.

## 4.3 BATTERY INSTALLATION.

The Type 1232-A Tuned Amplifier and Null Detector is powered by nine M72 mercury batteries (Mallory RM-4R or equivalent), which will last for over 1500 hours with normal use. For a simple check of the batteries, measure the dc voltage between anchor terminal 6 and ground. This should be 12 V.

To replace the batteries, remove the cap (twist counterclockwise and pull out) on the right-hand side of the instrument under the M72 CELLS engraving. Insert the 1½ in. spacer (P/N 1232-6010) in the opening on the right-hand side of the instrument, under the M72 CELLS engraving. Push it in to the end of the compartment. Then, insert the nine batteries with the positive (+) terminal as marked on the battery facing into the instrument. Finally place the cap (battery-keeper assembly, P/N 1650-2120) in position, twisting it approximately ¼ turn in either direction to lock it in position.



#### 4.4 INTERNAL NOISE.

##### 4.4.1 Noise Indicated by Meter.

At certain frequencies the sensitivity of the Type 1232-A Tuned Amplifier and Null Detector greatly exceeds the catalog specifications. With maximum gain at these frequencies, the noise generated by transistor Q100 normally causes large deflection of the output meter. For maximum useful gain, the GAIN control should be set low enough so that the noise level at the output is not greater than 10 percent of full scale.

For minimum sensitivity to hum pickup and stray fields, input connections must be shielded. Do not use an adaptor from the Type 874 INPUT connector to binding posts; use a shielded Type 874 cable.

If, with completely shielded input connections, the noise level of the Type 1232-A greatly exceeds the values given in Figure 6, the noise is probably caused by Q100. If it is necessary to replace this transistor, a replacement with a high  $\beta$  (beta) will usually give the lowest noise levels.

It is possible, but not likely, that Q101 will contribute significantly to the internal noise.

##### 4.4.2 Noise From the Type 1232-P2.

The equivalent noise sources of the Type 1232-AP with the FILTER FREQUENCY set to 100 Hz are a current source of less than  $0.1 \mu\mu\text{A}$  and a voltage source of less than  $0.3 \mu\text{V}$ . If the noise levels of the Type 1232 alone do not exceed the values of Figure 6, yet the Type 1232-AP will not meet the above specifications, replace the transistor in the Type 1232-P2.

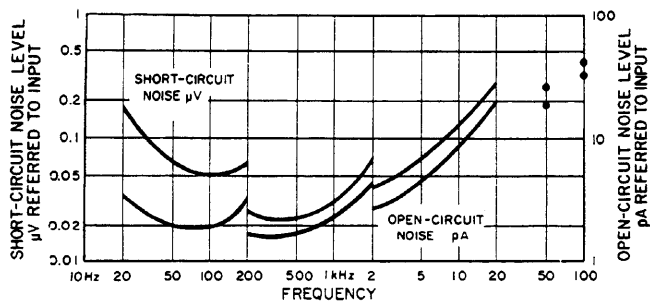

Figure 6. Typical noise levels as a function of frequency.

##### 4.4.3 Output Noise.

Due to the large amount of amplification that follows the GAIN control there is always a small amount of noise present at the OUTPUT terminals. At minimum gain, and with the FILTER FREQUENCY control set to FLAT or with a FILTER FREQUENCY of 5 kHz or lower, this noise should be less than 50 mV with the METER switch set to MAX SENS and should cause no more than 1 per-

cent deflection of the output meter. With the METER switch set to LINEAR -20 dB, this noise should be less than 5 mV.

If the noise is greater than 50 mV with minimum gain and MAX SENS switch setting, the trouble is probably caused by Q200, Q201, or Q202. If this noise level is less than 50 mV and the noise with LINEAR -20 dB switch setting is greater than 5 mV, the faulty component is probably Q203, Q204, or Q205.

#### 4.5 TRANSISTOR VOLTAGE AND RESISTANCE MEASUREMENTS.

Table 2 gives the normal voltage and resistance measurements from transistor terminals to ground. A deviation of 10 percent from any of these values is not necessarily abnormal.

1. Before making transistor voltage measurements, make sure that the battery voltage is approximately 12 V (refer to paragraph 4.3). Turn the instrument on but leave the GAIN control counterclockwise, set the FILTER FREQUENCY switch to FLAT and the METER switch to LINEAR -20 dB. Measure voltage with a high impedance voltmeter.

2. Before making resistance measurements, remove all the batteries and short-circuit anchor terminal 6 to ground. Remove all transistors. Set the GAIN control to OFF, the FILTER FREQUENCY switch to FLAT, and the METER switch to LINEAR -20 dB.

TABLE 2  
VOLTAGES AND RESISTANCES

Transistor (Type)	Term.	Dc Volts To Ground	Ohms To Ground	Transistor (Type)	Term.	Dc Volts To Ground	Ohms To Ground
Q100	C	7.8	222 k	Q202	C	0	0
	E	3.6	220 k		E	3.5	11 k
	B	3.7	3.3 M		B	3.3	22 k
Q101	C	11.6	2.2 k	Q203	C	1.7	100 k
	E	7.7	40 k		E	0.4	4.7 k
	B	7.8	222 k		B	0.5	42 k
Q200	C	7.4	34 k	Q204	C	3.6	47 k
	E	3.6	33 k		E	1.6	10 k
	B	3.7	120 k		B	1.7	100 k
Q201	C	3.3	22 k	Q205	C	7.2	4.4 k
	E	7.8	23 k		E	3.5	3.3 k
	B	7.4	34 k		B	3.6	47 k
Q101 of Type 1232-P2	D	12.0	3.2 k	* Impedance too high to permit measurement.			
	S	0.7 to 2.5	10 k				
	G	*	1 G				

#### 4.6 TRIMMER-CAPACITOR ADJUSTMENT.

Normally, the factory-set trimmer capacitor adjustment (C202) will not require attention. However, adjustment may be necessary if transistor Q201, Q203, or Q204 is replaced. If the frequency response for the FLAT characteristic is outside the specified limits, adjust the trimmer capacitor as follows:

a. With the FILTER FREQUENCY switch set at FLAT and a 1-kHz signal at the INPUT connector, adjust the GAIN control for a 5-dB meter indication.

b. With the GAIN and FILTER FREQUENCY controls unchanged, apply a 100-kHz signal (of the same amplitude as the 1-kHz signal) to the INPUT connector and adjust the trimmer capacitor, C202, for a meter indication of 5 dB. Check the frequency response below 100 kHz to make sure it is within the specified limits.

c. With same settings, use continuously variable source to check that response is flat within  $\pm 3$  dB from 20 Hz to 100 kHz. Adjust with C202, if necessary.

#### 4.7 MINIMUM PERFORMANCE STANDARDS.

##### 4.7.1 General

The following tests are provided to demonstrate compliance of the 1232-A with published specifications at incoming inspection or following repair or calibration.

##### 4.7.2 Test Equipment

The items listed in Table 3 are recommended for performance of the ensuing tests.

Table 3

Instrument	Recommended Type*
Decade Voltage Divider	GR 1455-B
Counter	GR 1192-B
Coaxial Adaptor	GR 874-Q10
Patch Cord	GR 776-A
Patch Cord	GR 776-B
Patch Cord	GR 274-NP
Shielded Patch Cord	GR 874-R34
Oscillator	GR 1310-B
Voltmeter	hp 400E
Short-Circuit Termination	GR 874-WNL
Open-Circuit Termination	GR 874-WO
Insertion Unit	GR 874-X
5.1 M $\Omega$ resistors, 5% (2 required)	_____

\*Or equivalent.

##### 4.7.3 Noise Check

Connect the Voltmeter to the 1232-A OUTPUT terminals (via the 776-A Patch Cord and set controls as follows:

- a. Voltmeter RANGE switch to 0.1 volts.
- b. 1232-A METER switch to MAX SENS.
- c. 1232-A FILTER FREQUENCY switch to FLAT.
- d. 1232-A GAIN control on, but fully ccw.

The voltmeter indication (noise) should be .03-V maximum.

#### 4.7.4 Filter Tuning Dial.

Connect equipment as shown in Figure 7.

Set controls as follows:

- a. Set oscillator to 1 kHz at 1 V output.
- b. Set 1455-B to .00100 (1 mV output.)
- c. Set 1192 in FREQUENCY mode.
- d. Set 1192 range switch to 1 s GATE TIME.
- e. Set 1192 DISPLAY control at 1 s.
- f. Set 1192 INPUT ATTEN at 1:1.
- g. Set 1232-A FILTER FREQUENCY switch to 200 Hz – 2 kHz.
- h. Set 1232-A METER switch to MAX SENS.

Set the FILTER TUNING dial on the 1232-A to each of the numbered points (2, 3, 4, 5, 7, 10, 15, 20) and adjust the 1232-A GAIN and the 1310 frequency for a peak reading on the 1232-A meter. In each case, the frequency read on the 1192 should be within  $\pm 3\%$  of the nominal value on the 1232-A FILTER TUNING dial. (See Table 4).

**Table 4**  
OSCILLATOR FREQUENCY SETTINGS

Hz	Hz
194-206	679-721
291-309	970-1030
388-412	1455-1545
485-515	1940-2060

Repeat the test at 100 Hz, 20 Hz, and 200 Hz on the 20-200 Hz range, and at 2, 10, and 20 kHz on the 2-20 kHz range. Also check 50- and 100-kHz (via the 1232-A FILTER FREQUENCY switch). In each case set the switch to its proper position before setting the frequency. The FILTER TUNING dial is not in the circuit at 50- and 100 kHz. At each step the FILTER TUNING dial should be accurate to within  $\pm 3\%$  of the frequency read on the 1192.

#### 4.7.5 Frequency Response

Set the following controls (same set-up as above):

- a. Set oscillator to 1 kHz at 1 V output.
- b. Set 1455-B to .01000 (10 mV.)
- c. Set 1232-A FILTER FREQUENCY switch to FLAT.

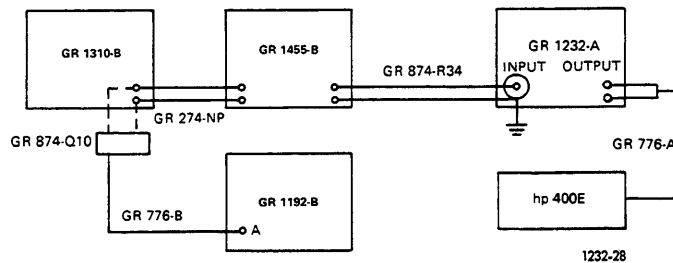

Figure 7. Filter Tuning Dial Test Set-up.

- d. Set 1232-A METER switch to MAX SENS.
- e. Adjust 1232-A GAIN for a 5 dB reading on the 1232-A meter. Change the frequency to 100 kHz and note a 1232-A meter reading of 2- 8dB.

With a constant input voltage, the frequency response from 100 kHz to 20 Hz should be between 2 and 8 dB.

Repeat the test at 100 Hz, 10 kHz, 50 kHz, and 100 kHz, adjusting the GAIN control for a 5 dB deflection in each case. Adjust the output of the 1310-B to 1 V at the start of each frequency test.

#### 4.7.6 Gain

Set the following:

- a. Set oscillator to 1 kHz at 1 V output.
- b. Set 1455-B to .9999X (1 V.)
- c. Set 1232-A FILTER TUNING dial to 10.
- d. Set 1232-A FILTER FREQUENCY switch to 200 Hz-2 kHz.
- e. Set 1232-A METER switch to MAX SENS.

Under these conditions it must be possible to adjust the 1232-A GAIN control for a full-scale reading on the 1232-A meter.

Repeat the test for full-scale deflection with the 1455-B set to .00001 and the 1310-B adjusted to 100 mV.

Set the GAIN control 135° clockwise from the off position and adjust the 1455-B for a full scale reading of the 1232-A meter. The 1455-B should indicate between .00320 and .03200 (320 μV—3.2 mV.)

#### 4.7.7 Meter Linearity

Set the following controls:

- a. Set the oscillator to 1 kHz at 1 V output.
- b. Set the 1455-B to .00320 (3.2 mV.)
- c. Set the 1232-A FILTER FREQUENCY switch to FLAT.
- d. Set the 1232-A METER switch to MAX SENS.

Adjust the GAIN control for full-scale (0 dB) on the 1232-A meter. Decrease the 1455-B output to 1.8 mV (65 dB); the 1232-A meter should indicate 4.7 to 5.3 dB.

Decrease the 1455-B output to 1 mV (.00100). The 1232-A meter should now read 9.5 to 10.5 dB.

Change the 1455-B output to 100 μV (.00010) and adjust the 1232-A GAIN for a full-scale reading on the 1232-A meter. Make the following checks:

1232-A METER switch	1455-B Output	1232-A meter must read:
-20 dB	.00010	5 to 7
LOG	.00010	40 to 60
LOG	.00010	Adjust GAIN to 20
LOG	.00100	60 to 90
LOG	.01000	80 to 100
LOG	.10000	greater than previous reading*

\*If reading goes down, the batteries may need replacement.

#### 4.7.8 Signal to Noise Ratio

Disconnect the 1192 from the set-up of Figure 7 and connect the voltmeter to the 1232-A OUTPUT. Set controls as follows:

- Set oscillator to 20 Hz at 100 mV output.
- Set 1232-A FILTER TUNING dial to 2.
- Set 1232-A FILTER FREQUENCY switch to 20-200 Hz.
- Set 1232-A METER switch to MAX SENS.

Disconnect the 1455-B from the 1232-A and short the 1232-A input with the 874-WNL. Adjust the GAIN control for an indication of 0.1 V on the voltmeter. Remove the input short and reconnect the 1455-B to the 1232-A INPUT. Adjust the 1455-B for an indication of 1.0 V on the voltmeter; this should require an output of 10  $\mu$ V maximum on the 1455-B.

Repeat the above procedure, for the following conditions:

Frequency*	Setting †
1 kHz	3.5 $\mu$ V
10 kHz	8 $\mu$ V
100 kHz	30 $\mu$ V

Set 1232 to 20 Hz. Disconnect the 1455-B and install the 874-WO at the 1232-A INPUT. Adjust GAIN for 0.1 V on the voltmeter. Remove the 874-WO. Connect, to the 1232-A input, a fixture consisting of two 5.1-M $\Omega$  resistors in series within the 874-X Insertion Unit. Connect the 1455-B to the other end of the fixture. With the oscillator at 20 Hz, adjust the 1455-B to produce a 1.0-V reading on the voltmeter. The 1455-B output should be 1 mV maximum.

Repeat the above procedure for the following conditions:

Frequency*	Setting †
1 kHz	700 $\mu$ V
10 kHz	2 mV
100 kHz	15 mV

#### 4.7.9 Harmonic Rejection

Use the set-up of Figure 7 and set controls as follows:

- Set oscillator to 1 kHz at 100 mV.
- Set 1455-B to .00001 (1  $\mu$ V).
- Set 1232-A FILTER TUNING dial at 10.
- Set 1232-A FILTER FREQUENCY switch at 200 Hz-2 kHz.
- Set 1232-A METER switch at MAX SENS.

\*Set filter tuning dials and filter frequency switch for appropriate frequencies.  
†Max. 1455-B setting to give 1.0-V reading on hp400E.

Adjust the GAIN control for a full-scale reading on the 1232-A meter. Set the oscillator at the following frequencies, and in each case readjust the output of the 1455-B to give a full-scale reading of the 1232-A meter. The 1455-B should indicate as follows:

Frequency	Minimum 1455-B output voltage
2 kHz	63 $\mu$ V (36 dB)
10 kHz	3.2 mV (70 dB) *
500 Hz	16 $\mu$ V (24 dB)
60 Hz	1 mV (60 dB)

Reset the oscillator to 100 Hz and the 1455-B to 1  $\mu$ V. With the 1232-A RANGE at 20-200 Hz, adjust the FILTER TUNING dial for a peak and adjust the GAIN control for a full-scale reading of the 1232-A meter. Change the oscillator to 200 Hz and readjust the 1455-B for a full-scale 1232-A meter reading. The 1455-B output must be 57  $\mu$ V (35 dB) minimum.

Set the oscillator to 10 kHz (as indicated on the 1192-B) at a 100 mV output. Set the 1455-B to .01000 (1 mV). With the 1232-A range at 2-20 kHz, adjust the FILTER TUNING dial for peak response on the 1232-A meter. Adjust GAIN for full-scale deflection. Turn the FILTER TUNING dial ccw to obtain a meter reading 3 dB below full scale. Turn the oscillator frequency dial ccw through a peak meter indication and beyond, until the 1232-A meter again reads 3 dB below full scale. The frequency, indicated on 1192 should be between 10.30 and 10.50 kHz.

Reset the oscillator to 10 kHz, the 1455-B to 1  $\mu$ V and the FILTER TUNING dial to 10. Tune the FILTER TUNING dial for a peak and adjust the GAIN for a full-scale deflection on the 1232-A meter. Change the oscillator to 20 kHz and readjust the 1455-B output for a full-scale reading on the 1232-A meter. The 1455-B must indicate 57  $\mu$ V (35 dB) minimum.

Set the oscillator to 50 kHz, the 1455-B to .00005 (5  $\mu$ V), and the FILTER FREQUENCY switch to 50 kHz. Adjust GAIN for full-scale on the 1232-A meter. Set the oscillator at the following frequencies, and in each case readjust the 1455-B output to give a full-scale reading on the 1232-A:

Frequency	Minimum 1455-B output voltage
100 kHz	1 mV (60 dB)
10 kHz	1.4 mV (63 dB)

Set the oscillator to 100 kHz at 100 mV output, the 1455-B to .00010 (10  $\mu$ V), and the FILTER FREQUENCY switch to 100 kHz. Adjust GAIN for full-scale on the 1232-A. Set the oscillator at the following frequencies, and in each case readjust the 1455-B output to give a full-scale reading on the 1232-A:

\* May not be able to get full-scale reading on 1232 with large input signal from 1455-B. Transistors in 1232 have reached max gain.

Frequency	Minimum 1455-B output voltage
20 kHz	1 mV (60 dB)
200 kHz	3.2 mV (70 dB)

#### 4.7.10 External Filter

Set the oscillator to 10 kHz at 1 V output, the 1455-B to .00010 (100  $\mu$ V), the FILTER FREQUENCY switch to FLAT, and the METER switch to MAX SENS. Connect the external filter, (set for 10-kHz band pass), to the EXTERNAL FILTER jack on the side of the 1232-A. Adjust the oscillator for peak reading on 1232-A, then adjust GAIN for full-scale. Change 1310 frequency to 100 kHz. Adjust the 1455-B for full-scale reading on the 1232-A meter. The 1455-B must indicate 1 mV (60 dB) minimum.

#### 4.8 KNOBS

If it should be necessary to remove a 1232 knob, to replace a damaged switch or knob, proceed as follows:

- a. Grasp the knob firmly with the fingers, close to the panel, and pull the knob straight away from the panel.
- b. Observe the position of the set screw in the bushing with respect to any panel markings.
- c. Release the set screw and pull the housing off the shaft, using an Allen wrench.

#### NOTE

To separate the bushing from the knob, if for any reason they should be combined off the instrument; drive a machine tap a turn or two into the bushing for sufficient grip for easy separation.

To install the snap-on knob assembly on the control shaft:

- a. Mount the bushing on the shaft, using a small slotted piece of wrapping paper as a shim for adequate panel clearance.
- b. Orient the set screw on the bushing with respect to the panel marking index and lock the set screw with an Allen wrench.

#### NOTE

Make sure the end of the shaft does not protrude through the bushing or the knob will not set properly.

- c. Place the knob on the bushing with the retention spring opposite the set screw.
- d. Push the knob in until it bottoms in the groove in the bushing.

#### NOTE

If the retention spring in the knob becomes loose, reinstall it in the interior notch with the small slit in the wall.



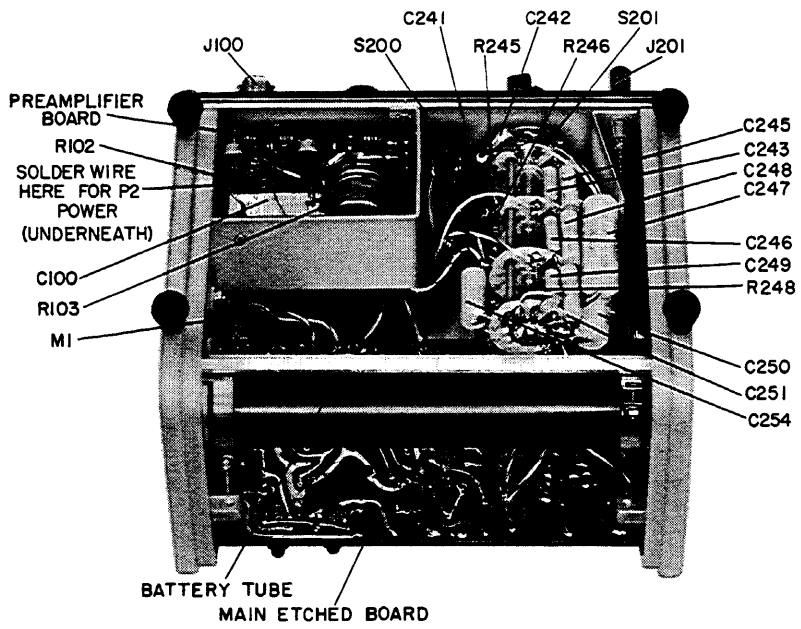

Figure 8. Bottom interior view of the Type 1232-A.

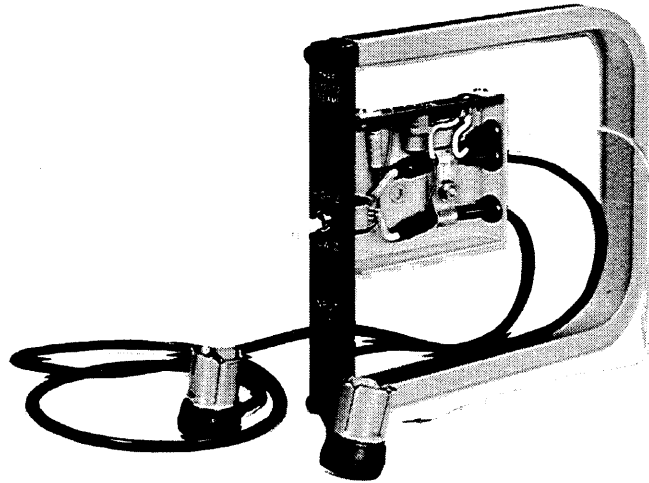

Figure 9. Interior of the Type 1232-P2.

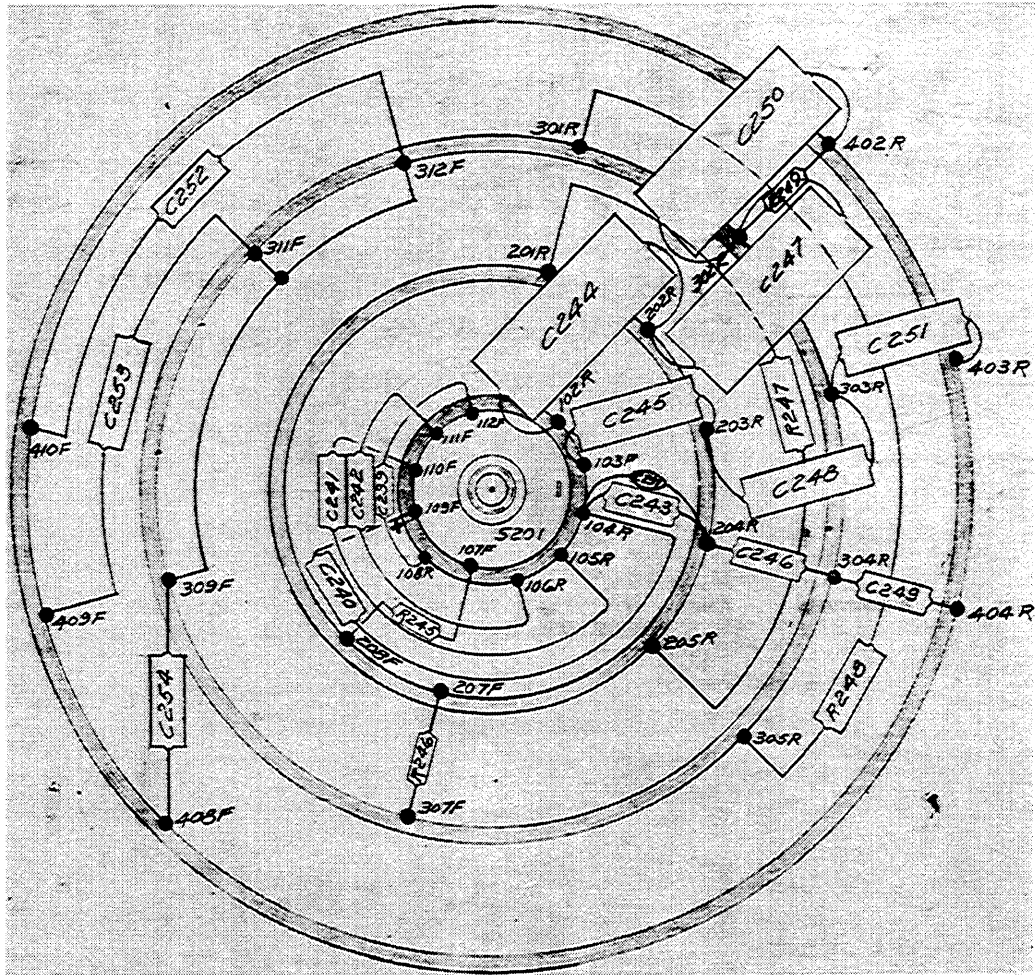

Figure 10. S201 wiring details. The 100-series lugs are at the panel end.

#### 4.9 INSTRUMENT METER WINDOW CARE

The clear acrylic meter window can become susceptible to electrostatic-charge buildup and can be scratched, if improperly cleaned. It is treated inside and out in manufacturing with a special non-abrasive anti-static solution, Statnul\*, which normally should preclude any interference in meter operation caused by electrostatic effects. The problem is evidenced by the inability of the meter movement to return promptly to a zero reading, once it is deenergized. As supplied, the meter should return to zero reading within 30 seconds, immediately following the placement of a static charge, as by rubbing the outside surface. This meets the requirements of ANSI standard C39.1-1972.

If static-charge problems occur, possibly as the result of frequent cleaning, the window should be carefully polished with a soft dry cloth, such as cheese-cloth or nylon chiffon. Then, a coating of Statnul should be applied with the polishing cloth.

#### CAUTION

Do not use any kind of solvent. Kleenex or paper towels can scratch the window surface.

If it should be necessary to place limit marks on the meter window, paper-based masking tape is recommended, rather than any kind of marking pen, which could be abrasive or react chemically with the acrylic.

---

\* Available from Mancib Co., Burlington, MA 01803

## ELECTRICAL PARTS LIST

CHASSIS MOUNTED PARTS P/N 1232-3010

REFDES	DESCRIPTION	PART NO.	FMC	MFGR	PART NUMBER
* BT 1	BATTERY 1.35V MERCURIC OXIDE M72	8410-1372	09823	HG-4R	
C 239	CAP TANT 6.8 UF 20PCT 6V	4450-4800	56289	150D685X0006A2	
C 240	CAP MYLAR .015UF 10 PCT 100V	4860-7655	56289	410P .015 UF 10PCT	
C 241	CAP MYLAR .0022UF 10 PCT 200V	4860-7329	56289	410P .0022 UF 10PCT	
C 242	CAP MYLAR .001UF 10 PCT 200V	4860-7309	56289	410P .001 UF 10PCT	
C 243	CAP MYLAR .00947UF 1 PCT 100V	4860-7553	56289	410P .00947 UF 1PCT	
C 244	CAP MYLAR 1UF 1 PCT 100V	4860-8003	56289	410P 1 UF 1PCT 100V	
C 245	CAP MYLAR .1UF 1 PCT 100V	4860-8249	56289	410P 0.1 UF 1PCT	
C 246	CAP MYLAR .01UF 1 PCT 100V	4860-7752	56289	410P .01 UF 1PCT	
C 247	CAP MYLAR 1UF 1 PCT 100V	4860-8003	56289	410P 1 UF 1PCT 100V	
C 248	CAP MYLAR .1UF 1 PCT 100V	4860-8249	56289	410P 0.1 UF 1PCT	
C 249	CAP MYLAR .01UF 1 PCT 100V	4860-7752	56289	410P .01 UF 1PCT	
C 250	CAP MYLAR 1UF 1 PCT 100V	4860-8003	56289	410P 1 UF 1PCT 100V	
C 251	CAP MYLAR .1UF 1 PCT 100V	4860-8249	56289	410P 0.1 UF 1PCT	
C 252	CAP MYLAR .0033UF 10 PCT 200V	4860-7359	56289	410P .0033 UF 10PCT	
C 253	CAP MYLAR .047UF 10 PCT 100V	4860-8200	56289	410P .047 UF 10PCT	
C 254	CAP MYLAR .22UF 10 PCT 100V	4860-7981	56289	410P 0.22 UF 10PCT	
C 257	CAP CER DISC 100PF 5PCT 500V	4404-1105	72982	083108225D00101J	
J 100	PANEL CONNECTOR	0874-4181	24655	0874-4181	
J 102	CONNECTOR JACK	4260-0400	82389	2J-1439	
J 103	JACK SINGLE .030 PIN	4260-1010	98291	SKT-0804	
J 200	BINDING POST ASM	0938-3000	24655	0938-3000	
J 201	BINDING POST ASM	0938-3000	24655	0938-3000	
M 1	METER	5730-1220	24655	5730-1220	
Q 100	TRANSISTOR 2N4384	8210-1131	56289	2N4384	
Q 101	TRANSISTOR 2N4384	8210-1131	56289	2N4384	
Q 200	TRANSISTOR 2N4384	8210-1131	56289	2N4384	
Q 201	TRANSISTOR 2N4250	8210-1294	07263	2N4250	
Q 202	TRANSISTOR 2N4250	8210-1294	07263	2N4250	
Q 203	TRANSISTOR 2N3903	8210-1132	04713	2N3903	
Q 204	TRANSISTOR 2N3903	8210-1132	04713	2N3903	
Q 205	TRANSISTOR 2N3903	8210-1132	04713	2N3903	
R 245	RES COMP 1.8 K 5PCT 1/2W	6100-2185	81349	RCR20G182J	
R 246	RES COMP 3.3 K 5PCT 1/2W	6100-2335	81349	RCR20G332J	
R 247	RES FLM 19.5 OHM 1 PCT 1/2W	6450-9196	81349	RN65D19R6F	
R 248	RES FLM 6.65K 1 PCT 1/2W	6450-1665	81349	RN65D6651F	
R 249	RES COMP 200 K OHM 5PCT 1/2W	6100-4205	81349	RCR20G204J	
R 250	POTENTIOMETER	0975-4040	24655	0975-4040	
S 200	SWITCH TOGGLE 3POS DP STEADY	7910-0820	04009	82609	
S 201	SWITCH ROTARY ASM	7890-2410	24655	7890-2410	

TUNEJ AMPLIFIER PC BOARD P/N 1232-2701

REFDES	DESCRIPTION	PART NO.	FMC	MFGR	PART NUMBER
C 100	CAP MYLAR 0.15UF 10 PCT 600V	4860-9400	56289	411P 0.15 UF 10PCT	
C 101	CAP TANT 1.0 UF 20PCT 35V	4450-4300	56289	150D105X00035A2	
C 102	CAP ALUM 100 UF 15V	4450-2800	56289	30D107G015	
C 103	CAP TANT 6.8 UF 20PCT 6V	4450-4800	56289	150D685X0006A2	
C 104	CAP TANT 4.7 UF 20PCT 10V	4450-4700	56289	150D475X0010A2	
CR 100	DIODE RECTIFIER 1N4003	6081-1001	14433	1N4003	
CR 101	DIODE RECTIFIER 1N4003	6081-1001	14433	1N4003	
CR 102	DIODE RECTIFIER 1N4003	6081-1001	14433	1N4003	
CR 103	DIODE RECTIFIER 1N4003	6081-1001	14433	1N4003	
R 100	RES COMP 3.3 K 5PCT 1/2W	6100-5335	81349	RCR20G335J	
R 101	RES COMP 220 K 5PCT 1/2W	6100-4225	81349	RCR20G224J	
R 102	RES COMP 2.2 K 5PCT 1/2W	6100-2225	81349	RCR20G222J	
R 103	POTENTIOMETER	1232-0400	24655	1232-0400	
R 104	RES COMP 220 K 5PCT 1/2W	6100-4225	81349	RCR20G224J	
R 105	RES COMP 22 K 5PCT 1/2W	6100-3225	81349	RCR20G223J	
P 106	RES COMP 18 K 5PCT 1/2W	6100-3185	81349	RCR20G183J	
S 100	POTENTIOMETER	1232-0400	24655	1232-0400	

\* 9 BATTERIES REQUIRED

## ELECTRICAL PARTS LIST

PC BOARD P/N 1232-2711

REFDES	DESCRIPTION	PART NO.	FMC	MFR	PART NUMBER
C 200	CAP ALUM 5 UF 50V	4450-3900	56289	30D505G050	
C 201	CAP MICA 220 PF 5PCT 500V	4700-0519	81349	CM05FD221JN	
C 202	CAP CER TRIM 8-50 PF	4910-1170	72982	557-051 E 8-50PF	
C 204	CAP MICA 30 PF 5PCT 500V	4700-0237	81349	CM05ED300JN	
C 205	CAP ALUM 200 UF 6V	4450-2610	56289	30D207G006	
C 206	CAP MICA 100 PF 5PCT 500V	4700-0660	81349	CM05FD101JN	
C 207	CAP ALUM 100 UF 15V	4450-2800	56289	30D107G015	
C 208	CAP ALUM 100 UF 15V	4450-2800	56289	30D107G015	
C 209	CAP MYLAR .22UF 10 PCT 100V	4860-7981	56289	410P 0.22 UF 10PCT	
C 210	CAP TANT 10 UF 20PCT 20V	4450-5100	56289	150D106X0020B2	
C 211	CAP CER TUB 680PF 5PCT 500V NM OV NM	4404-1685	72982	31525R680PF10PCT500	
C 212	CAP ALUM 5 UF 50 V	4450-3900	56289	30D505G050	
C 213	CAP CER TUB 680PF 5PCT 500 V NM OV NM	4404-1685	72982	31525R680PF10PCT500	
C 214	CAP ALUM 5 UF 50V	4450-3900	56289	30D505G050	
C 215	CAP ALUM 5 UF 50V	4450-3900	56289	30D505G050	
C 216	CAP ALUM 5 UF 50V	4450-3900	56289	30D505G050	
C 217	CAP ALUM 15 UF 15V	4450-3700	56289	30D156G015	
C 218	CAP ALUM 5 UF 50V	4450-3900	56289	30D505G050	
C 219	CAP MYLAR .464UF 2 PCT 100V	4860-7990	56289	410P 0.464 UF 2PCT	
C 220	CAP MYLAR .464UF 2 PCT 100V	4860-7990	56289	410P 0.464 UF 2PCT	
C 221	CAP MYLAR .464UF 2 PCT 100V	4860-7990	56289	410P 0.464 UF 2PCT	
C 222	CAP MICA 464PF 1PCT 500V	4710-0535	81349	CM05FD464FN	
C 223	CAP MICA 464PF 1PCT 500V	4710-0535	81349	CM05FD464FN	
C 224	CAP MICA 464PF 1PCT 500V	4710-0535	81349	CM05FD464FN	
C 225	CAP MICA 1000PF 1PCT 500V	4710-0100	81349	CM06FD102FN	
C 226	CAP MICA 1000PF 1PCT 500V	4710-0100	81349	CM06FD102FN	
C 227	CAP MICA 1000PF 1PCT 500V	4710-0100	81349	CM06FD102FN	
C 230	CAP MYLAR .01UF 2 PCT 100V	4860-7650	56289	410P .01 UF 2PCT	
C 231	CAP MYLAR .00681UF 2 PCT 200V	4860-7505	56289	410P .00681 UF 2PCT	
C 255	CAP TANT 4.7 UF 20PCT 10V	4450-4700	56289	150D475X0010A2	
C 256	CAP MICA 1000 PF 5PCT 500V	4700-1190	81349	CM06FD102JN	
CR 200	DIODE RECTIFIER 1N4003	6081-1001	14433	1N4003	
CR 201	DIODE RECTIFIER 1N4003	6081-1001	14433	1N4003	
CR 202	DIODE RECTIFIER 1N4003	6081-1001	14433	1N4003	
CR 203	DIODE RECTIFIER 1N4003	6081-1001	14433	1N4003	
CR 204	DIODE 1N191 90PIV IR 125UA GE	6082-1008	14433	1N191	
CR 205	DIODE 1N191 90PIV IR 125UA GE	6082-1008	14433	1N191	
L 201	CHOKER MOLDED 1000 UH 10PCT	4300-5000	99800	3500-32	
L 202	CHOKER MOLDED 390 UH 10PCT	4300-4390	99800	3500-22	
R 200	RES CCMP 33 K 5PCT 1/2W	6100-3335	81349	RCR20G333J	
R 201	RES COMP 33 K 5PCT 1/2W	6100-3335	81349	RCR20G333J	
R 203	RES COMP 1.0 K 5PCT 1/2W	6100-2105	81349	RCR20G102J	
R 204	RES COMP 220 K 5PCT 1/2W	6100-4225	81349	RCR20G224J	
R 205	RES COMP 220 K 5PCT 1/2W	6100-4225	81349	RCR20G224J	
R 206	RES COMP 1.0 K 5PCT 1/2W	6100-2105	81349	RCR20G102J	
R 207	RES COMP 22 K 5PCT 1/2W	6100-3225	81349	RCR20G223J	
R 208	RES COMP 470 OHM 5PCT 1/2W	6100-1475	81349	RCR20G471J	
R 210	RES COMP 22 K 5PCT 1/2W	6100-3225	81349	RCR20G223J	
R 211	RES COMP 10 OHM 5PCT 1/2W	6100-0105	81349	RCR20G100J	
R 212	RES CCMP 10 K 5PCT 1/2W	6100-3105	81349	RCR20G103J	
R 213	RES COMP 470 OHM 5PCT 1/2W	6100-1475	81349	RCR20G471J	
R 214	RES CCMP 110 K OHM 5PCT 1/2W	6100-4115	81349	RCR20G114J	
R 215	RES CCMP 150 K 5PCT 1/2W	6100-4155	81349	RCR20G154J	
R 216	RES COMP 27 K 5PCT 1/2W	6100-3275	81349	RCR20G273J	
R 217	RES COMP 47 K 5PCT 1/2W	6100-3475	81349	RCR20G473J	
R 218	RES CCMP 100 K 5PCT 1/2W	6100-4105	81349	RCR20G104J	
R 220	RES COMP 4.7 K 5PCT 1/2W	6100-2475	81349	RCR20G472J	
R 221	RES CCMP 2.7 K 5PCT 1/2W	6100-2275	81349	RCR20G272J	
R 222	RES COMP 47 K 5PCT 1/2W	6100-3475	81349	RCR20G473J	
R 223	RES COMP 10 K 5PCT 1/2W	6100-3105	81349	RCR20G103J	
R 224	RES COMP 12 K 5PCT 1/2W	6100-3125	81349	RCR20G123J	
R 225	RES COMP 3.9 K 5PCT 1/2W	6100-2395	81349	RCR20G392J	
R 226	RES CCMP 3.3 K 5PCT 1/2W	6100-2335	81349	RCR20G332J	
R 227	RES COMP 1.8 K 5PCT 1/2W	6100-2185	81349	RCR20G182J	
R 228	RES COMP 3.0 K OHM 5PCT 1/2W	6100-2305	81349	RCR20G302J	
R 230	RES CCMP 9.1 K OHM 5PCT 1/2W	6100-2915	81349	RCR20G912J	
R 231	RES COMP 22 K 5PCT 1/2W	6100-3225	81349	RCR20G223J	
R 232	RES COMP 9.1 K OHM 5PCT 1/2W	6100-2915	81349	RCR20G912J	
R 233	RES FLM 31.6K 1 PCT 1/8W	6250-2316	81349	RN55D3162F	
R 234	RES FLM 31.6K 1 PCT 1/8W	6250-2316	81349	RN55D3162F	

## ELECTRICAL PARTS LIST (cont)

NULL DETECTOR PC BOARD P/N 1232-2711

REFDES	DESCRIPTION	PART NO.	FMC	MFGR	PART NUMBER
R 235	RES FLM 3.32K 1 PCT 1/8W	6250-1332	81349	RN5503321F	
R 236	RES FLM 3.32K 1 PCT 1/8W	6250-1332	81349	RN5503321F	
R 237	RES FLM 40.2K 1 PCT 1/8W	6250-2402	81349	RN5504022F	
R 238	RES COMP 1.0 K 5PCT 1/2W	6100-2105	81349	RCR20G102J	
R 239	RES FLM 5.11K 1 PCT 1/8W	6250-1511	81349	RN5505111F	
R 240	RES FLM 5.11K 1 PCT 1/8W	6250-1511	81349	RN5505111F	
R 241	RES FLM 1.1K 1 PCT 1/8W	6250-1110	81349	RN5501101F	
R 242	RES FLM 4.99K 1 PCT 1/8W	6250-1499	81349	RN5504991F	
R 243	RES FLM 4.99K 1 PCT 1/8W	6250-1499	81349	RN5504991F	
R 244	RES FLM 1.05K 1 PCT 1/8W	6250-1105	81349	RN5501051F	
R 251	RES COMP 2.7 K 5PCT 1/2W	6100-2275	81349	RCR20G272J	

## MECHANICAL PARTS LIST

DESCRIPTION	PART NO.	FMC	MFGR	PART NUMBER
FILTER TUNING KNOB ASM	5520-5520	24655	5520-5520	
GAIN & FILTER FREQ KNOB ASM	5500-5221	24655	5500-5221	
BATTERY HOLDER TUBE	1232-6000	24655	1232-6000	
FILTER TUNING DIAL INDICATOR	5470-0650	24655	5470-0650	
RIGHT END FRAME ASM	5310-3066	24655	5310-3066	
LEFT END FRAME ASM	5310-3067	24655	5310-3067	
FEET (4 REQUIRED)	5260-0700	24655	5260-0700	

## ELECTRICAL PARTS LIST

1232-P2 PREAMPLIFIER CHASSIS MOUNTED PARTS

REFDES	DESCRIPTION	PART NO.	FMC	MFGR	PART NUMBER
S 101	SWITCH TOG MIN 2POS DPDT STEADY	7910-0791	95146	MTA-206N	

1232-P2 PREAMPLIFIER PC BOARD P/N 1232-2730

REFDES	DESCRIPTION	PART NO.	FMC	MFGR	PART NUMBER
C 101	CAP MYLAR .001UF 10 PCT 200V	4860-7309	56289	410P .001 UF 10PCT	
Q 101	TRANSISTOR 2N3457	8210-1082	17856	2N3457	
R 101	RES COMP 1.0 K 20PCT 1/2W	6100-3108	81349	RCR20G108	
R 102	RES COMP 10 K 5PCT 1/2W	6100-3105	81349	RCR20G103J	
R 103	RES COMP 1.0 K 5PCT 1/2W	6100-2105	81349	RCR20G102J	

Figure 11. Schematic diagram of the Type 1232-A Tuned Amplifier and Null Detector.

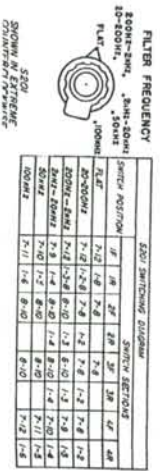

**FILTER FREQUENCY**

SWITCH POSITION	500-1000 KHZ	1-2 MHz	2-3 MHz	3-4 MHz	4-5 MHz	5-6 MHz	6-7 MHz	7-8 MHz	8-9 MHz	9-10 MHz
500-1000 KHZ	5.0	1.5	2.0	2.5	3.0	3.5	4.0	4.5	5.0	5.5
1-2 MHz	1.5	2.0	2.5	3.0	3.5	4.0	4.5	5.0	5.5	6.0
2-3 MHz	2.0	2.5	3.0	3.5	4.0	4.5	5.0	5.5	6.0	6.5
3-4 MHz	2.5	3.0	3.5	4.0	4.5	5.0	5.5	6.0	6.5	7.0
4-5 MHz	3.0	3.5	4.0	4.5	5.0	5.5	6.0	6.5	7.0	7.5
5-6 MHz	3.5	4.0	4.5	5.0	5.5	6.0	6.5	7.0	7.5	8.0
6-7 MHz	4.0	4.5	5.0	5.5	6.0	6.5	7.0	7.5	8.0	8.5
7-8 MHz	4.5	5.0	5.5	6.0	6.5	7.0	7.5	8.0	8.5	9.0
8-9 MHz	5.0	5.5	6.0	6.5	7.0	7.5	8.0	8.5	9.0	9.5
9-10 MHz	5.5	6.0	6.5	7.0	7.5	8.0	8.5	9.0	9.5	10.0

**500-1000 KHZ**

**500-1000 KHZ**

**500-1000 KHZ**

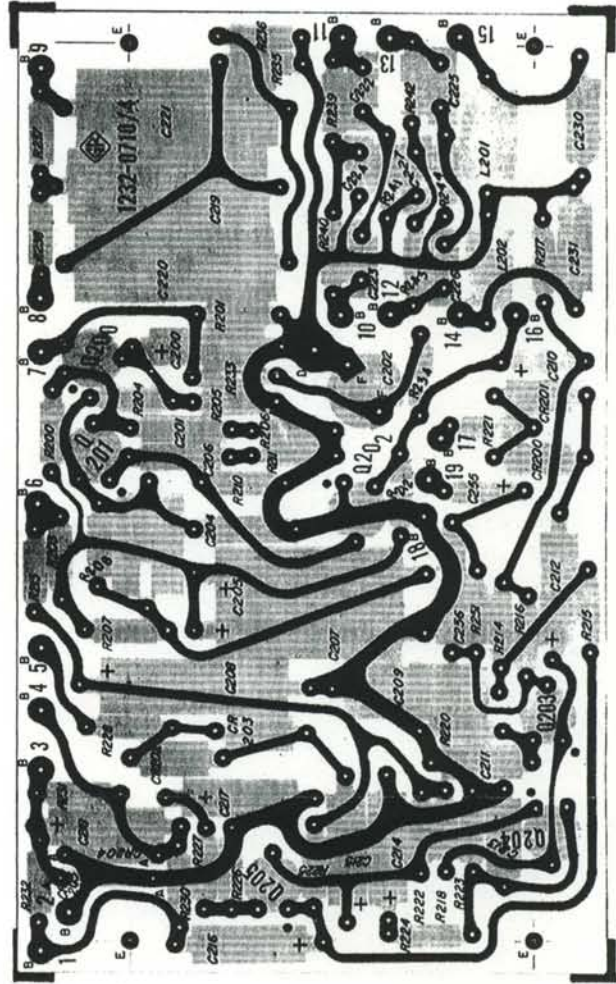
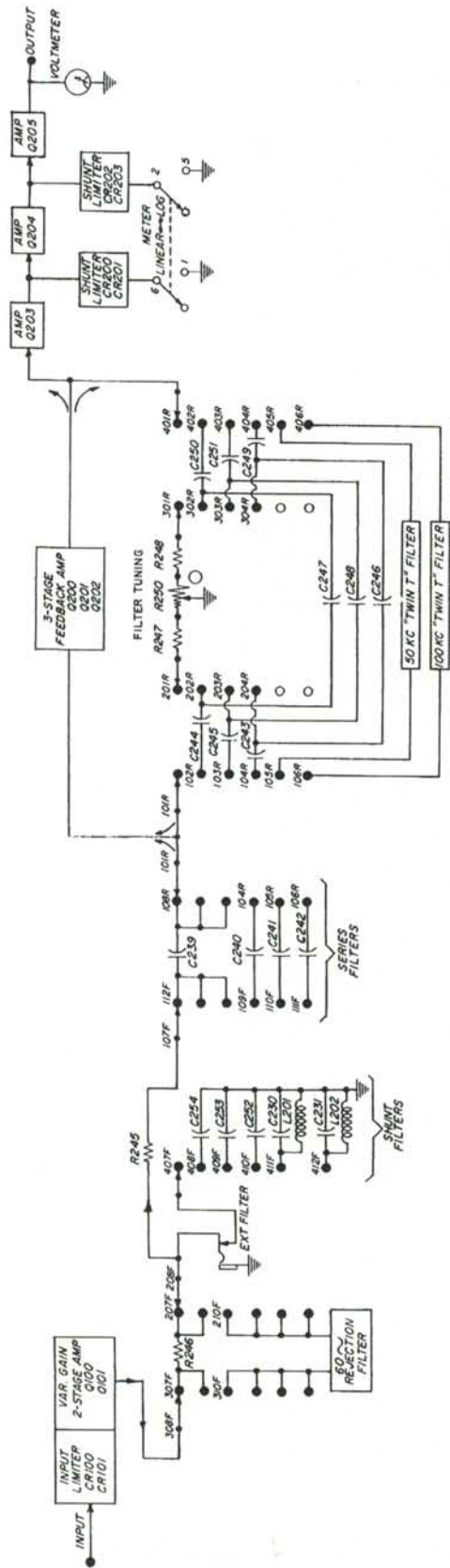

NOTE: The number appearing on the foil side is not the part number. The dot on the foil at the transistor socket indicates the collector lead.

Figure 13. Etched Board Layout of the Type 1232-A Tuned Amplifier and Null Detector, P/N's 1232-2700 and 1232-2710.



Figure 12. Block diagram of the Type 1232-A Tuned Amplifier and Null Detector.

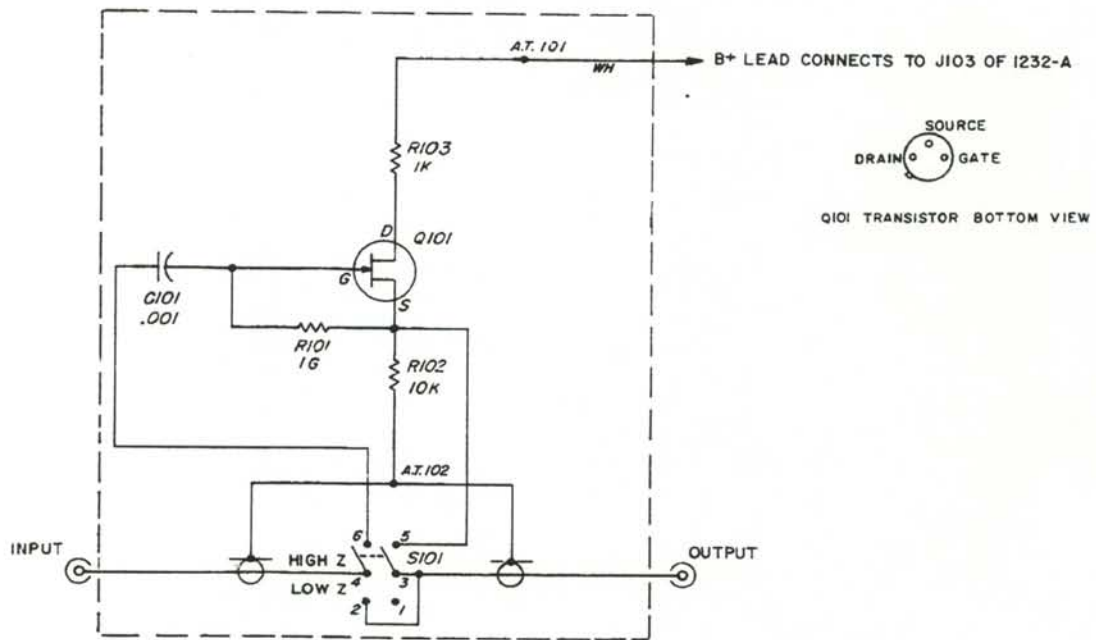
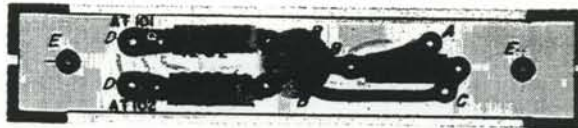

Figure 14. Schematic diagram and etched board layout of the Type 1232-P2 Preamplifier. The etched board part number is 1232-2730.

